

---

# CONTENTS

<b>BRAND IDENTITY</b>	5
Brand voice & Tone of voice	6
Effective communication is crucial	7
<b>VISUAL IDENTITY</b>	8
Logo	8
Colour	17
Typography	24
Icons	26
Programme logos	27
<b>REAL ESTATE</b>	28
House style manual	28
Customer Guiding System	29
Partnership signage	43
EV-charging points manual	48
Mobility Hub signage manual	55
A1 frames	87
<b>STATIONARY</b>	89
Digital stationary	89
Printed stationary	91
<b>COMMUNICATIONS</b>	96
Guidelines	96
Conventions for visuals and the logo	106
Tone of voice and Writing guidelines	107
Corporate English style guide	114
Tools	121
Q-Park terminology	123
Marketing Communications Code	139
Tone of voice	140
<b>PR</b>	141
Press / Media protocol	141
Guidelines	143
<b>PHOTOGRAPHY</b>	147
<b>APPENDICES</b>	166

---

## FIGURES

Figure 1: Logo	8
Figure 2: Logo and safe zone	8
Figure 3: Logo in master and reverse version	8
Figure 4: Logo in monochrome and reverse version	8
Figure 5: Definition of parameters Q, x and y	9
Figure 6: Logo with pay-off	10
Figure 7: Safe zone around logo with pay-off	10
Figure 8: Master and reverse logo with pay-off	11
Figure 9: Stacked master logo with pay-off	11
Figure 10: Master logo with add-on: Powered by Q-Park	12
Figure 11: Safe zone surrounding logo with add-on	12
Figure 12: Logo in shape - square	12
Figure 13: Logo in shape - circle	13
Figure 14: Logo with parking facility name	13
Figure 15: Safe zone logo and co-branding	16
Figure 16: Logo and co-branding examples	16
Figure 17: Q-Park logo colours	17
Figure 18: Q-Park Primary Colours	17
Figure 19: Primary brand colour Q-Park red	17
Figure 20: Secondary colours	18
Figure 21: Secondary brand colour Q-Park green	18
Figure 22: Secondary brand colour Q-Park blue	20
Figure 23: Secondary brand colour Q-Park light blue	20
Figure 24: Bar chart example - 4 data points	21
Figure 25: Pie chart example - 5 data points	21
Figure 26: Pie chart example - 6 data points	22
Figure 27: Line graph example - 7 data points	22
Figure 28: Line graph example - z data points	22
Figure 29: Typeface Futura T	24
Figure 30: Futura T Demi vs Futura T Bold	24
Figure 31: Arial typeface	25
Figure 32: Icons for motorists, in PFs, are red	26
Figure 33: Icons for pedestrians, in PFs, are green	26
Figure 34: Icons for activities and services	26
Figure 35: SMP Programme - Logo text	27
Figure 36: SMP Programme - Logo	27
Figure 37: PaSS logo	27
Figure 38: PaSS logo with pay-off	27
Figure 39: PaSS logo, pay-off and Powered by Q-Park	27
Figure 58: Q.01 Illuminated sign on column	29
Figure 59: Signage angled from the ceiling	33
Figure 60: Illuminated P-sign for motorists on column	34
Figure 61: Illuminated P-sign for motorists on facade	35

---

Figure 62: Illuminated P-sign for pedestrians on column	36
Figure 63: Illuminated P-sign for pedestrians on facade	37
Figure 64: Illuminated P-sign for pedestrians on column, historic sites	38
Figure 65: Pre-printed stationary grid (A4 portrait)	91
Figure 66: Pre-printed stationary grid (A4 landscape)	91
Figure 67: A4 letterhead grid	92
Figure 68: A4 continuation sheet grid	93
Figure 69: Envelope examples	93
Figure 70: With complements card grid	94
Figure 71: Business card grid	95
Figure 72: Job advertisement - Recruitment case study 1	97
Figure 73: Basic poster grid	96
Figure 74: Basic poster grid - three levels	98
Figure 75: Basic poster grid - CTA	99
Figure 76: Basic poster grid - co-branding	100
Figure 77: Poster example - Brand message	100
Figure 78: Poster example - USP message	101
Figure 79: Poster example - Campaign message	101
Figure 80: Poster example - Informative message	102
Figure 81: Poster example - Prices & Services	102
Figure 82: PMS display gripper / cardholder	103
Figure 83: Logo don'ts	166
Figure 84: Logo and pay-off don'ts	166
Figure 85: Logo and naming don'ts	167
<b>TABLES</b>	
Table 1: RGB colour scheme - 4 data points	21
Table 2: RGB colour scheme - 5 data points	21
Table 3: RGB colour scheme - 6 data points	21
Table 4: RGB colour scheme - SMP logo	27



# BRAND IDENTITY

---

The Q-Park Brand Identity is all about how we present ourselves and how we want to be recognised and perceived by stakeholders. In essence it is a promise of what people can expect from us.

## Brand identity

- | | Our name, logo, colours, shapes and other visual elements in our parking facilities, services and promotions.
- | | Our language in communications.
- | | How we interact with customers.
- | | Our international consistency, in both tangible and digital materials.
- | **Brand image** is the actual result of these efforts.
- | **Brand equity** is the measurable totality of a brand's worth.
  - | | The Q-Park trade name, an intangible fixed asset, is valued at more than EUR 50 million.
- | **Brand voice** helps us help us consistently communicate our purpose and vision, in- and externally.
  - | | Our **purpose** is to enhance urban liveability and connect communities by providing sustainable mobility solutions and seamless parking services.
  - | | Our **vision** is to be the most preferred sustainable mobility hub partner by 2030.

Q-Park **Brand Identity** is a strategic marketing tool to support business development and increase customer satisfaction, with side effects such as economy of scale and reduced price sensitivity.

- | Q-Park's **Brand Toolbox** and **Marketing Methods** help Q-Park to distinguish itself from competitors.
- | Q-Park's **Brand Manager** is focused on long term stewardship to create and maintain shareholder value.

This manual describes the Q-Park Brand Identity in detail and contains digital references, downloads and interaction options. Everyone in the Q-Park organisation who communicates in- and/or externally bears responsibility for adhering to, as well as building and maintaining the Q-Park Brand.

## Guiding principles

- | Contact Corporate Brand Manager
  - | | If you have questions, suggestions and/or additional requirements.
  - | | When you wish to develop something new.
  - | | If you wish to adapt something that already exists.
- | Direct downloadable items are clearly indicated.
- | Indirect downloadable items are clearly indicated (and can be found in Idefix).
- | Always use the Q-Park templates for Word, Excel and PowerPoint documents.

By following the Q-Park Brand Identity guidelines for all our expressions, in-house, online and in print, we all contribute to 'Quality in parking' and reinforce the Q-Park Brand.

---

# BRAND VOICE & TONE OF VOICE

Our **Brand Voice** is the core of our brand's personality. It must be consistent across all content and all channels.

Our **Tone of Voice** expresses the mood and feeling of the voice, and may change depending on the context. For example, we write to customers in e-mails and social media in a friendly and **informal** tone of voice, while our writing in our financial and annual reporting is a little more **formal** but remains clear, compelling and concise.

In this guide, we explain the Q-Park **Brand Voice** and **Tone of Voice** and how best to write in Q-Park style.

---

# EFFECTIVE COMMUNICATION IS CRUCIAL

We communicate with our customers, business partners and colleagues every day. It's important that what we write and say is easy to understand.

George Orwell, best known for his dystopian novel 1984 has had a considerable influence on language and writing. He set out six rules for writing, which are still applicable today:

1. *Never use a metaphor, simile, or other figure of speech which you are used to seeing in print.*
2. *Never use a long word where a short one will do.*
3. *If it is possible to cut a word out, always cut it out.*
4. *Never use the passive where you can use the active.*
5. *Never use a foreign phrase, a scientific word, or a jargon word if you can think of an everyday English equivalent.*
6. *Break any of these rules sooner than say anything outright barbarous.*

Q-Park communication follows these guidelines too.

## Accessible communication

Whether you're writing in English or your local language, please ensure your text is accessible to all. Accessible communication works better for everyone including people who are:

- I disabled
- I neurodivergent
- I tired, stressed, anxious or distracted.

## Corporate language is British English

At Q-Park, British English is our corporate language. We have chosen this English variant as it most commonly used in Europe and is also the language used in two of our country organisations.

## Local languages

Each Q-Park country communicates with its customers and partners in their local language(s).

# VISUAL IDENTITY

---

## LOGO

Figure 1: Logo

---



Figure 2: Logo and safe zone

---



Figure 3: Logo in master and reverse version

---



Figure 4: Logo in monochrome and reverse version

---





The Q-Park name was introduced in 1995. The Q-Park logo dates from 1996 and its brand identity elements date from 2004. The Q-Park logo is a stylised name with three illustrative 'angled parking spaces' and its accompanying colours (black, red and white) are always used in the same way.

Download Q-Park logo

### Safe zone

It is important to give the logo space without adding other graphic elements. A safe zone has been defined.

The safe zone is defined as the height of one of the illustrative angled parking spaces – we refer to this height as  $x$ . This safe zone always surrounds the logo and is always in proportion to the logo, whatever its size.

### Colour

For wide-ranging applicability, clarity and strength, the use of colour in the logo is restricted to two colours: black (or white in reverse use) and red. For colour references, see the Primary brand colours section.

### Q-Park logo and size parameters

We have 3 parameters for calculations within the house style,  $Q$ ,  $x$  and  $y$ .

- $Q$  = the size of the large  $Q$  in Q-Park
- $x$  = the height of the angled parking space in the logo

$y$  = the total width of the logo plus the pay-off

All further calculations for the various templates and grids can be made using these values.

### Logo with pay-off

The logo may be combined with Q-Park's pay-off 'Quality in parking'. The size and position of the pay-off with logo is fixed. Only in highly exceptional circumstances may the pay-off be placed under the logo.

The preferred position of the logo with pay-off in all executions is at the bottom right of the page.

Download Q-Park logo with pay-off

Figure 5: Definition of parameters  $Q$ ,  $x$  and  $y$



Figure 6: Logo with pay-off



### Safe zone

Q-Park sells space and space is part of the Q-Park Brand. It is vital to place the logo in its own space without adding other graphic elements. To help you get this right, we have defined the minimum space to surround the logo, we call this the safe zone. It gives the Q-Park logo the space it deserves to convey our recognised quality image.

To calculate the minimum free space surrounding the logo, take the height of one of the illustrative angled parking spaces, = x as shown in figure 2 and add this free space to all sides of the logo. This safe zone is always in proportion to the size of the logo, however large or small.

You may not place other graphic elements in the Q-Park logo safe zone.

Figure 7: Safe zone around logo with pay-off



### Use of colour

For wide-ranging applicability, clarity and strength, the use of colour in the basic logo is restricted to two colours: black (or white in reverse use) and red.

Black and grey may only be used if colour is not possible. For colour references, see the Primary brand colours section.

Figure 8: Master and reverse logo with pay-off



**Stacked logo**

If width is an issue, the pay-off may be stacked.

[Download Q-Park logo stacked](#)

Figure 9: Stacked master logo with pay-off



## Logo with add-on

Besides the logo with pay-off, the only other additions to the logo are described here.

Other texts than 'Powered by' may not be added to the logo.

[Download Q-Park logo - Powered by](#)

## Logo and shapes

Sometimes it is necessary to place the logo in a closed shape, for example to identify a parking facility on a map. The space surrounding the logo must always respect the safe zone rules.

[Download Q-Park logo](#)

### In square

Position the logo in the centre of the square, both vertically and horizontally.

Figure 10: Master logo with add-on: Powered by Q-Park

Powered by 

Figure 11: Safe zone surrounding logo with add-on



Figure 12: Logo in shape - square



### In a circle

Position the logo in the centre of the circle, both vertically and horizontally.

## Logo and names

### Parking facility signage

The Q-Park logo may be combined with the parking facility name on signs in and around the parking facility. All parking facilities display the parking facility name above the entrance; this is the master logo plus the parking facility name. This design was developed by our house style architects. The corporate Real Estate Department has technical drawings with all details including the dimensions and use of the building materials.

### Parking facility names

The name of the parking facility should be logical and chosen in consultation with country management. The name should be easily recognisable as it may refer to a well-known Point Of Interest (POI) nearby: theatre,

shopping centre, office, museum, hospital, airport, famous square, and the like.

The correct notation is always: Q-Park plus parking facility name. The letters used for the parking facility name must have same the height as the word 'PARK' in the logo.



### Commercial signage

We prefer not to use third-party commercial signs in combination with our own Customer Guiding System

Figure 13: Logo in shape - circle



Figure 14: Logo with parking facility name

**Q-PARK** / **MUSEUMPLEIN**

(CGS) house style. But sometimes combining the Q-Park master logo with commercial partner logos is a good way to guide customers. See the Real Estate Department's Customer Guiding System manual for further details.

## Names and abbreviations

The name of a service, business unit, or department always consists of the written word 'Q-Park' followed by the relevant name.

Q-Park is always written with a capital Q and capital P, with a hyphen between the Q and the P. The first letter of the service, entity, department, or parking facility, name is also capitalised.

Examples:

- | Q-Park Beheer BV
- | Q-Park Ireland Ltd
- | Q-Park Park + Ride

The name of a service, company, business unit, or department may not be combined with the logo. By way of exception, the logo may be combined with the parking facility name on signs in and around the parking facility.

Q-Park may not be omitted in a name and must certainly not be bastardised.

For internal services and/or projects the letter 'Q' may be used in combination with other letters/words - only allowed in body copy - if this is executed without the Q-Park logo and/or the letter 'Q' of the logo.

Examples:

- | QCR: Q-Park Control Room
- | QCD: Q-Park Customer Desk
- | QIS: Q-Park ICT Services
- | QFS: Q-Park Financial Services

When referring to multiple Q-Park companies and countries the sequence from a reporting perspective is as follows:

- | Q-Park Netherlands
- | Q-Park Germany
- | Q-Park France
- | Q-Park Belgium

- | Q-Park United Kingdom
- | Q-Park Ireland
- | Q-Park Denmark

To indicate the legal form of a company, follow the official notation used in the country concerned. This sequence shows the official notation and the historical sequence of expansion:

- | Holding: Q-Park BV
- | Netherlands: Q-Park Beheer BV
- | Germany: Q-Park GmbH & Co. KG
- | Belgium: Q-Park Belgium NV
- | United Kingdom: Q-Park Ltd
- | France: Q-Park France
- | Ireland: Q-Park Ireland Ltd
- | Denmark: Q-Park Denmark A/S

## Logo and co-branding

In some circumstances the Q-Park logo may be required in combination with the name of a commercial partner. Ensure that the size of the partner logo is proportioned to the Q-Park logo so that both logos attract equal attention. The two logos are separated by the safe zone plus a vertical line to the left of the Q-Park logo including the safe zone space.

Figure 15: Safe zone logo and co-branding

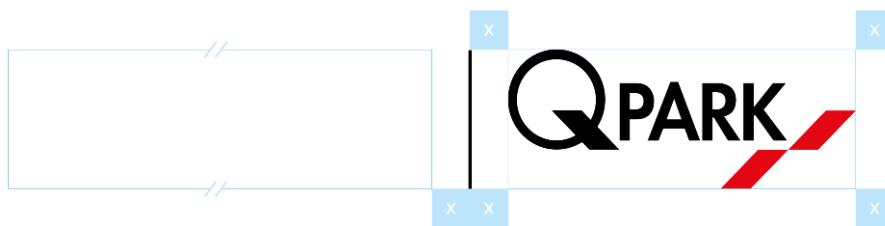

Figure 16: Logo and co-branding examples





## COLOUR

Colour plays an important role in the Q-Park Brand and supports the recognition of Q-Park in the market. Always use the primary brand colours. These can be used in various ways and in almost all media. Unambiguous and uniform colour use gives a harmonious and consistent 'look and feel' to Q-Park's expressions.

### Primary colours

The Q-Park primary brand colours are the colours we use in the logo and as element in various expressions for recognition. Of the logo colours, **red** stands out.

Red also stands for energy, passion, strength, warmth, speed and leadership.

**Black** is the second primary brand colour. Where appropriate, you may also use grey tint or a percentage of black.

**White** is the most dominant colour in Q-Park expressions, it stands for space, fresh, open and clarity.

Figure 17: Q-Park logo colours



Figure 18: Q-Park Primary Colours



Figure 19: Primary brand colour Q-Park red



For wide-ranging applicability, clarity and strength, the colour in the master logo is restricted to two colours: black (or white in reverse use) and red.

Download colours for Adobe Indesign, Illustrator and Photoshop

Red may only be used as a full background colour on certain clothing items and the Q-Park litter bins. When using the logo on a red background, use the black monochrome logo.

**Colour codes for Q-Park red:**

- | CMYK: C0 M100 Y100 K0 – for full colour printing
- | Pantone: PMS 485 – for printing
- | RAL: RAL 3020 – for painting
- | RGB: R217 G3 B39 – for office applications
- | HEX: #D90327 – for web design
- | 3M: 3630-043

**Colour codes for Q-Park black:**

- | CMYK: C0 M0 Y0 K100 – for full colour printing
- | Pantone: Black – for printing
- | RAL: 9005 – for painting
- | RGB: R0 G0 B0 – for office applications
- | HEX: #000000 – for web design 3630

**Secondary colours**

If it is not possible to use colour in the logo, red may be replaced with 60 % black

We have Q-Park green and Q-Park blue to support the primary brand colours. Q-Park green may be used to accentuate certain elements. Q-Park blue may only be used by Real Estate for on-street signage.

The colour red is the most recognisable (distinguishing) colour and is used as an accent.

PLEASE NOTE: Q-Park green changed in Q4 2022 due to real estate film changes (from 3M to Orocal film).

Figure 20: Secondary colours



Figure 21: Secondary brand colour Q-Park green



### Colour codes for Q-Park green

- | CMYK: C50 M0 Y100 K0 – for full colour printing
- | Pantone: 376 – for printing
- | RAL: 6018 – for painting
- | RGB: R135 G215 B0 – for office applications
- | HEX: #87d700 – for web design
- | Oracal: 8500-63 (lime tree green) – for real estate (translucent film)

Q-Park green is used for customer guidance in our parking facilities and as an accent or functional colour on the websites, for example, for buttons and other clickable items.

**Colour codes for Q-Park blue**

- | CMYK: C100 M90 Y0 K10 – for full colour printing
- | Pantone: PMS 2748 – for printing
- | RAL: 5002 – for painting
- | RGB: R0 G56 B123 – for office applications
- | HEX: #00387b – for web design
- | 3M: 3630-87 (Blue)

Q-Park blue is the parking category colour. This is only used by Real Estate for on-street signage in the public domain, in particular to direct customers to parking facility entrances for motorists and pedestrians.

**Colour codes for Q-Park light blue**

- | CMYK: C80 M20 Y0 K0 – for full colour printing
- | Pantone: PMS 299 – for printing
- | RAL: 5012 – for painting
- | RGB: R0 G175 B250 – for office applications
- | HEX: #00AFFA – for web design
- | Oracal: 8500-53

Q-Park light blue is used for EV charging in our parking facilities and as an accent or functional colour with regards to EV charging, electricity storage and production.

Figure 23: Secondary brand colour Q-Park light blue

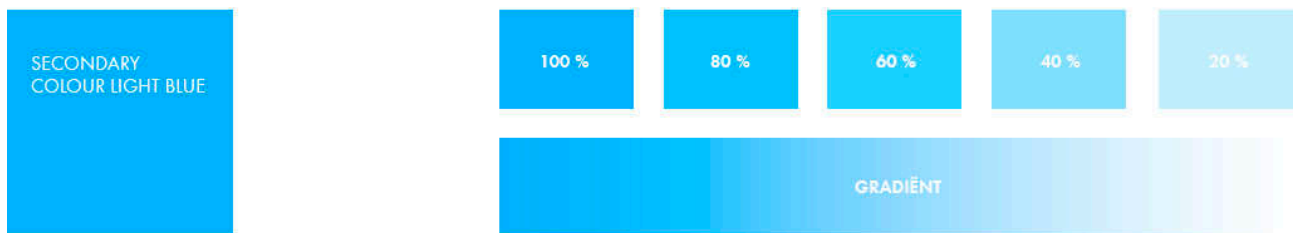
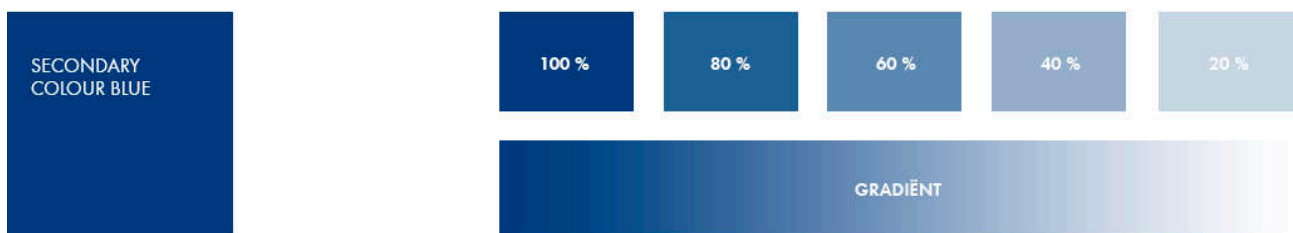

Figure 22: Secondary brand colour Q-Park blue



## Charts & Graphs

### Colour scheme - 4 data points

Table 1: RGB colour scheme - 4 data points

RGB	R	G	B
Red	217	3	39
Black	0	0	0
Dark grey	90	90	90
Mid grey	180	180	180

Figure 24: Bar chart example - 4 data points

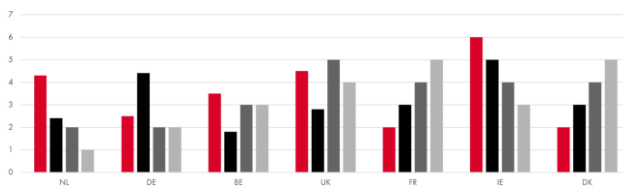

### Colour scheme - 5 data points

Table 2: RGB colour scheme - 5 data points

RGB	R	G	B
Red	217	3	39
Black	0	0	0
Dark grey	90	90	90
Mid grey	180	180	180
Light grey	240	240	240

Figure 25: Pie chart example - 5 data points

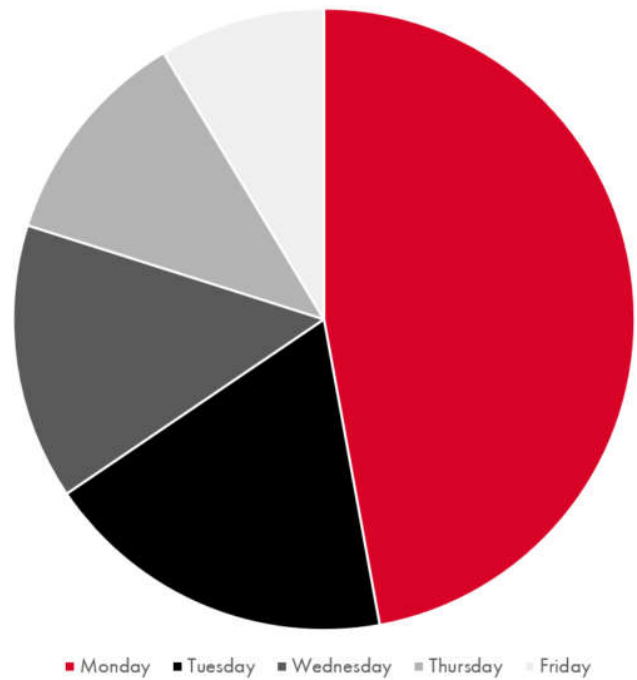

### Colour scheme - 6 data points

Table 3: RGB colour scheme - 6 data points

RGB	R	G	B
Red	217	3	39
Black	0	0	0
Dark grey	90	90	90
Mid grey	180	180	180
Light grey	240	240	240
White	255	255	255

Figure 26: Pie chart example - 6 data points

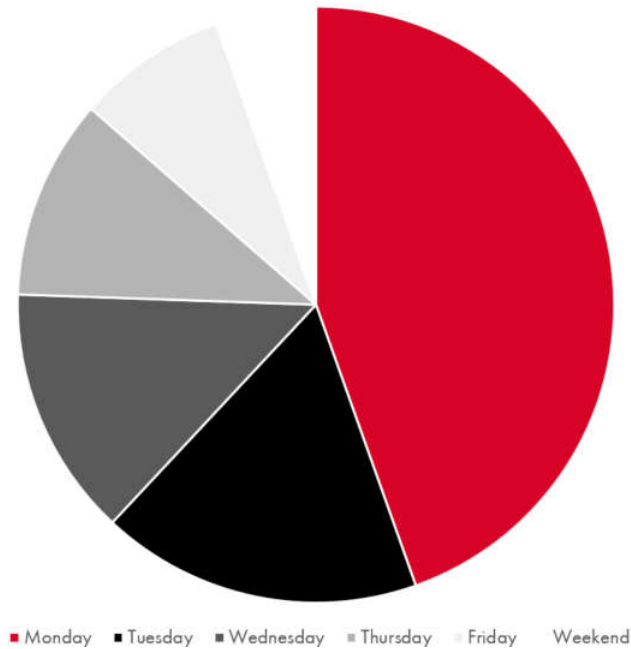

**Colour scheme - 7 data points (customise)**

- | Play with colour black, red and grey
- | Play with line weights and dashes
- | Additional grey tones:
  - | Mid-dark grey RGB 135-135-135
  - | Mid-light grey RGB 215-215-215

Figure 27: Line graph example - 7 data points

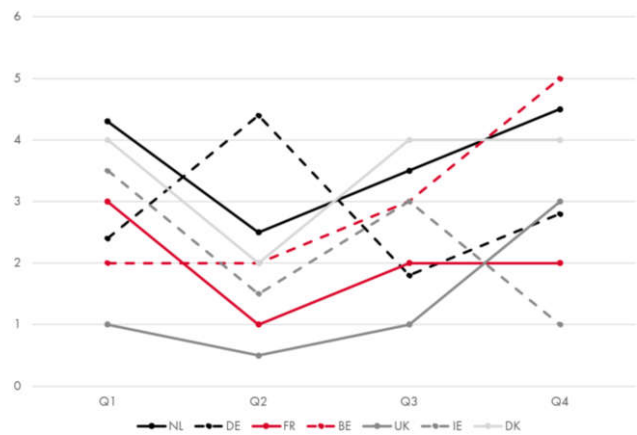

**Colour scheme - z data points (customise)**

- | Play with colour black, red, grey and **green**
- | Play with line weights and dashes

Figure 28: Line graph example - z data points

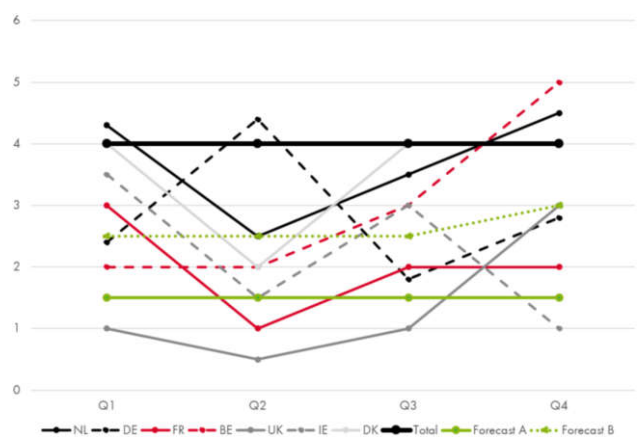

**RGB overview**

Q-Park Microsoft Office Applications have a default colour theme. If you need more colours:

- | Select ... More colours (in Font colour, Shape Fill or Shape Outline)
- | Select ... Custom tab

- | Select ... Colour model RGB\*
- | Fill out R, G and B numbers of desired colour

Colours	R	G	B
	<b>Standard</b>		
Red	217	3	39
Black	0	0	0
Dark grey	90	90	90
Mid grey	180	180	180
Light grey	240	240	240
	<b>Customised</b>		
Mid-dark grey	135	135	135
Mid-light grey	215	215	215
Green	139	182	17
Blue	0	56	123

\* RGB is a colour scheme for your monitor, the three colours Red, Green and Blue produce over 16 million hues of light (if you need other colour schemes such as CMYK, PMS, RAL, HEX of 3M – [click here](#)).

# TYPOGRAPHY

## Primary typeface

The typeface used for Q-Park's Brand Identity is Futura T. This typeface must be used for all communication. We use:

- I Futura T 11pts
- I Line spacing 1.5<sup>1</sup>
- I Futura T Demi for emphasis.

Futura T makes an efficient and clear impression. The design principles are non-decorative; it is a business-like, easy to read, no-nonsense typeface. If it is not possible to use Futura T, use Arial.

Download Q-Park fonts - Futura T & Futura T Demi

### Futura T

Note: Only Futura T, Futura T Demi and Arial are permitted.

In all Q-Park expressions, whatever the medium, the word and letter spacing may not be adjusted in any way, nor may the letters be widened, narrowed, skewed or modified.

Do not use **bold in Futura T** for emphasis as this variant of the typeface does not space evenly. Instead use the Futura T Demi typeface which is naturally 'bold'. The

Figure 29: Typeface Futura T

A B C D E F G H I J K L M N O P Q R S T U V W X Y Z	Book
a b c d e f g h i j k l m n o p q r s t u v w x y z	
A B C D E F G H I J K L M N O P Q R S T U V W X Y Z	Medium
a b c d e f g h i j k l m n o p q r s t u v w x y z	
A B C D E F G H I J K L M N O P Q R S T U V W X Y Z	Demi
a b c d e f g h i j k l m n o p q r s t u v w x y z	

<sup>1</sup> Providing space is what we do, in our parking facilities and all other interactions with our customer groups; parking space supports the motorist, well-spaced copy supports the reader.

following visual shows the alignment differences (the bold number jumps too far to the left and is no longer aligned with the others), this may be confusing for readers, especially when tables become more complex.

Figure 30: Futura T Demi vs Futura T Bold

<b>FuturaT Demi</b>	€ 1.100.00
	€ 3.000.00
	€ 6.000.00
	<b>€ 10.100.00</b>
<b>FuturaT Bold</b>	€ 1.100.00
	€ 3.000.00
	€ 6.000.00
	<b>€ 10.100.00</b>

For emphasis in running text, you may use *italics* or **Futura T Demi**, however, do not underline text that will be read online or on screen because underline is reserved for links.



---

## Secondary typeface

The secondary brand typeface is Arial 10pts and is used for:

- I Documents which are sent in digital form to third parties;
- I When Futura T is not available on the computer.

Text columns are preferably evenly spaced. Word and letter spacing may not be adjusted in any way, nor may the letters be widened, narrowed, skewed or modified.

### Arial

The Arial font is supplied by default with Windows and Apple computers and is therefore always available for recipients of Q-Park documents.

Figure 31: Arial typeface

---

A B C D E F G H I J K L M N O P Q R S T U V W X Y Z	Regular
a b c d e f g h i j k l m n o p q r s t u v w x y z	

---

A B C D E F G H I J K L M N O P Q R S T U V W X Y Z	Regular Italic
a b c d e f g h i j k l m n o p q r s t u v w x y z	

---

A B C D E F G H I J K L M N O P Q R S T U V W X Y Z	Bold
a b c d e f g h i j k l m n o p q r s t u v w x y z	

---

A B C D E F G H I J K L M N O P Q R S T U V W X Y Z	Bold Italic
a b c d e f g h i j k l m n o p q r s t u v w x y z	

---

## ICONS

In addition to reinforcing the house style in terms of colour and form, icons are mainly used to convey a meaning graphically. The Q-Park icons represent a service, object, action, idea or function.

Figure 32: Icons for motorists, in PFs, are red



Icons for pedestrians, in PFs, are green

Figure 33: Icons for pedestrians, in PFs, are green



Q-Park icons visualise activities and services available in a parking facility. These are indicated in parking facility signage (white on a red, green, blue or light-blue background). They are also shown on parking facility pages of the country websites as monochrome grey icons.

Q-Park icons are available in various formats (AI, PNG and SVG) and some of them in a variety of colours. As there are many icons and frequent additions and/or updates, please check IDEFIX for the latest versions.

If you have any queries about the Brand Identity or need help applying it, please feel free to send an e-mail to [sacha.oerlemans@q-park.com](mailto:sacha.oerlemans@q-park.com)

Figure 34: Icons for activities and services



# PROGRAMME LOGOS

## SMP

Sustainable Mobility Partner (SMP) Programme

Figure 35: SMP Programme - Logo text



Figure 36: SMP Programme - Logo



Table 4: RGB colour scheme - SMP logo

RGB	R	G	B
Red	217	3	39
Blue	0	56	113
Mid-dark grey	135	135	135
Green	139	182	17

## PaSS

Parking as a Smart Service (PaSS). For more information, [click here](#).

Figure 37: PaSS logo



Figure 38: PaSS logo with pay-off



PARKING AS A SMART SERVICE

Figure 39: PaSS logo, pay-off and Powered by Q-Park



PARKING AS A SMART SERVICE

Powered by Q-Park

# REAL ESTATE

## HOUSE STYLE MANUAL

Real Estate **house style** finds expression in our parking facilities by application of house style characteristics, and especially the design of these characteristics.

Design as important contribution to house style characteristics

- | Colour concept
- | Parking layout & routing
- | Transparency
- | Lighting concept

House style characteristics

- | Entry car park
- | Parking equipment
- | Internal signage
- | Pedestrian signage
- | Typical house style elements

### Colour concept

Our colour concept is characterised by the application of a limited amount of neutral colours.

- | Floors (floor coating and lineation on concrete, asphalt or brick pavement) : white, grey or anthracite.
- | Floor coating, in house style colours, contributes strongly to the house style characteristics, but the application is not a condition: it strongly depends on the underground and the need to protect the construction.
- | Columns / walls / ceilings : white, grey or natural concrete.

The use of these calm colours contrasts well with the parking equipment, internal signage and striking house style elements and finally contributes to a better orientation.



# CUSTOMER GUIDING SYSTEM

Q-Park aims to provide their customers with well-located, easily accessible and safe parking facilities. In these parking facilities the customers find: clean surfaces, clear layouts, convenient parking spaces and welcoming illumination. Additionally we have worked on a signage system that harmonises with our total architectural design concept. The advertising signs within the parking facilities have been designed in a way not to interfere or conflict with the CGS-standard.

Signage and architectural design should harmonise, with the latter providing the overall atmosphere. At a detailed level, the signage guides the customer through our parking facilities, gives information where needed and supports our brand.

Figure 58: Q.01 Illuminated sign on column

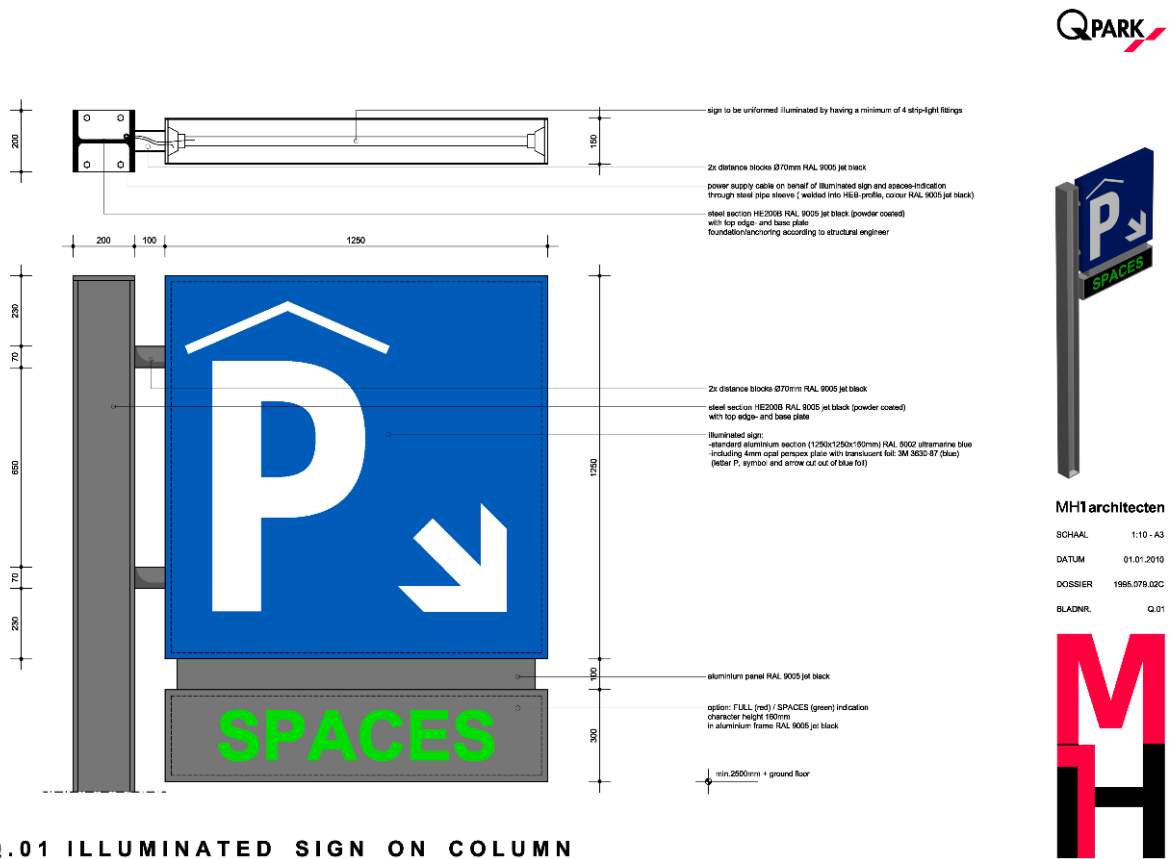

## Procedures

### Project Lead

The local **Project Manager** is responsible for the realisation of the project. The PM is responsible for:

- Creating a proper project description.

- Getting all the necessary technical and operational information.
- Collecting enough drawings, sketches and other necessary items, to complete the project according to Q-Park standards.

## Project Knowhow

- | Signs are mostly fixed on the ceiling. Ducts, trunks, light fittings and beams can easily interfere or obstruct the signs.
- | Health & Safety and other statutory signage can also interfere with, or even obstruct the signs.
- | All technical information and other signage needs (drawings of plans and sections, available pictures, et cetera) must be at hand before designing the signage plan.
- | Less is more i.e. design and layout should be clear, a minimum of signage is sufficient to guide our customers.
  - | Necessary traffic signs at car entry (speedlimit, height, tidal flow-traffic, ...)
  - | Necessary information in car park at decision points.
  - | Mandatory information such as escape routes.
- | Avoid country specific signs as Q-Park is an international brand.
  - | If needed signs are not available on IDEFIX, send a request to [idefix@q-park.com](mailto:idefix@q-park.com) with a proposal and explanation of the need.
  - | If the request is granted, it will be designed and added to the IDEFIX toolkit.
  - | The sign has to be put in the project plan and on the sign list to enable easy maintenance.
- | Each signage plan adheres to the Q-Park Housestyle Rules & Principles.
- | Each signage plan is signed-off by Corporate Car Park Design and MH1.

## Project Tools

IDEFIX holds all files to create a signage-plan; drawings, icons, visual references, et cetera.

- | The standard language is British English.
- | Country specific languages are made by the PM.
- | Supply correct names, terms and references when a signage-plan is to be made by MH1.

## Project Team

A PM cannot work alone on a signage plan. A PM sets-up a design meeting with Operations and Marketing colleagues to discuss plans, as they need to provide their requirements on operational and commercial needs, for early consideration.

- | Questions to be answered by Operations are:
  - | locations of the payment machine,
  - | which means of payment,
  - | where is the night entry,
  - | what kind of services are provided, et cetera?
- | Marketing questions include:
  - | locations of information signs,
  - | locations of advertising signs,
  - | illuminated signs,
  - | LCD screens, et cetera.

## Project Procedures

There are two ways to proceed on the design of the signage plan.

- | A) The PM takes care of the design.
  - | The PM is fully responsible for designing, manufacturing and fixing of the signage plan.
  - | The PM may always consult Corporate Car Park Design.
- | B) The PM puts in a request at Corporate Car Park Design (working together with MH1).
  - | PM share all aforementioned information with CCPD, who will share with MH1.
  - | MH1 provides, in most cases, also parking bay drawings and road markings.
  - | MH1 asks, when needed, for the right format in which the information, pictures and drawings have to be provided, in order to proceed and respond rapidly.
    - | (Note: floor plans are often not enough to proceed.)
  - | MH1 creates a proposal which will be shared by the CCPD with the PM. It includes a list of all signs, with its picture and reference number.
  - | PM:

- | Final control and remarks, preferably on-site.
- | Informs Operations and Marketing and gathers their remarks.
- | The signage plan with remarks are shared with CCPD and MH1.
- | MH1 processes all remarks and creates a set of final drawings.
- | PM receives final set and obtains all necessary files from IDEFIX.

### Project Execution

The PM must pay attention when fixing the signs as in most cases our signs are the last to be erected, there is a chance of unforeseen obstruction. I.e. just sticking to the original plan may end in non-visible signs, adjustments have to be made.

### Adjustments

- | Adjustments may occur while executing the original plan, and while operating the parking facility.
- | Executed adjustments must always be put in a revised plan, so replacements and repairs are based on correct plans.
- | Revised plans may be made by the local sign maker or by MH1, this is up to the PM.

### Maintenance

A signage plan is a tool to be used during the lifetime of a parking facility. Therefore:

- | Each sign has its own code **and/or a set** of codes form a sign.
- | Code numbers are placed on the **signage plan (not drawing)** showing location and layout.
- | The signage plan is accompanied by a list of code number, **the location and the way of fixing will be shown within that code list.**

## Design consideration

### Branding

Besides signage, there is branding. On IDEFIX you may find a variety of examples with typical branding solutions, helping you with your signage proposal.

- | Branding items **must be** designed by CCPD (MH1). They will support the PM where needed.
- | MH1 provides a proposal, awaiting feedback and/or approval from CCPD and PM.
- | PM checks the signage plan and conducts a final control onsite.
- | PM acquires the necessary permits and agreements to erect branding items.

### Advertising

Has to be designed according to the standard.

### Signage

When creating a signage plan, picture yourself as a Q-Park customer, as motorist and as pedestrian.

- | Motorists on the public road see our exterior **blue** P sign.
- | Motorists in our PF, driving and parking, follow **red** signs.
- | Pedestrians in our PF exiting the PF follow **green** signs.
- | Pedestrians on the public road see our exterior **blue** signs.
- | Motorists exiting our PF follow **red** signs.

In some cases the design of a parking facility cannot be changed. However, we always seek to design the clearest rotation and guide the customer with proper markings and arrows on parking floors.

- | Signs for motorists are kept to a minimum, providing only essential information, where choices need to be made.
- | Orientation signage shows at least the floor level, in some cases section and bay number.
- | We may show empty spaces available by VMS (Variable Message Sign).
- | We keep the exit route as short as possible.

- | Signs for pedestrians are kept to a minimum too, only for way finding, directions, orientation and information.
  - | Signage for pedestrian exit and if choices are possible, show this at an early stage.
    - | If only one exit option, signs are only at the exit itself with its name on the exit sign.
  - | Signage for lifts, parking floor and section.
  - | Pictograms for customer services such as the information desk, toilets and pay-stations.
  - | Information frames are used for a city plan, parkings tariffs and opening hours, special events, etc.

## Descriptions

When designing a signage-plan house style rules and principles must be applied.

All designs regarding signage and house style must be approved by Corporate Car Park Design (CCPD) and MH1.

### In general

- | Readable height - most PFs are low of clear height, signs can be difficult to fix while still being readable for customers. The clear height underneath a sign must never be lower than the clear head height of the PF.
  - | Signs for motorists may at the lowest height of 2.10 meters if this increases readability.

- | Signs for pedestrians may not be lower than the clear height of doors.
- | If the available height is insufficient, you may suspend angled signage from the ceiling, gaining about 11 centimeters clear height.
- | Readability and glare - glare from illumination is one of the biggest problems we experience as it makes signs unreadable. Only one type of foil solves this issue, make sure your sign manufacturer uses these materials:
  - | Cover the sign (aluminum plates) with mat white foil type 3M 3635-20.
  - | Finalise the sign with translucent mat foil, either
    - | Red 3M 3630-43 for motorists
    - | Green 3m 2630-106 for pedestrians
  - | It is up to the sign maker to place white information (3M 3635-20) on the coloured foil or is cut-out of the coloured foil.
- | New developments on how to assemble the sign
  - | Normally the sign is assembled out of a core of WBP plywood 18mm and painted black + two plane aluminum plates of at least 2mm glued on and covered with mat white foil type 3M 3635-20.
  - | New is a type of alu-bond with a mat white coating. This may be used as well and may create a cost saving.



Figure 59: Signage angled from the ceiling

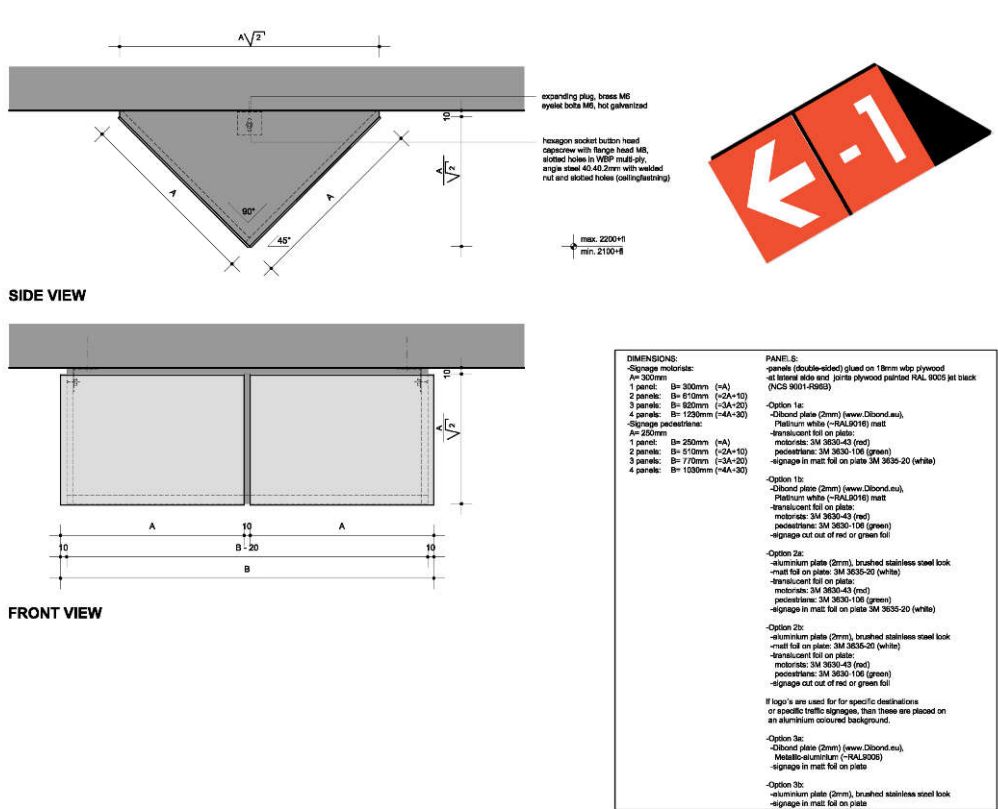

MH1architecten

SCHAAL 1.5 - A3

DATUM 01.01.2010

DOSSIER 1996.079.04C

BLADNR. Q.32B



**Q.32B SIGNAGE, SUSPENDED ON CEILING (45°)**

To avoid glare, use the right mat foils.

**External signage**

- I Motorists - an illuminated Q-Park P-sign signpost.
  - I Sometimes it will be the last sign as part of and in addition to Variable Message Signs (VMS) or Parking Guiding Systems. If so, you may decide to not use the FULL/SPACES indicator.
  - I Depending on the local situation it may be fixed on a column, a facade or an element of our portal frame.
  - I These signs are traffic signs and need to attract as much attention as possible. Please note that in most cases

local planning consent and permits are required.

- I These signs are specifically designed per parking facility (PF) by MH1 and/or CCPD.
- I Pedestrians - an illuminated sign for night entrance
  - I When customers are finding their way back to the PF, a blue P-sign guides them to the pedestrian entry.
  - I The sign shows the name of the PF and our Q-Park logo.
  - I When a pedestrian entry sign cannot be fixed to the facade or a column near the entrance, there is a more sophisticated solution for historic areas.
  - I These signs are specifically designed per parking facility (PF) by MH1 and/or CCPD.

Figure 60: Illuminated P-sign for motorists on column

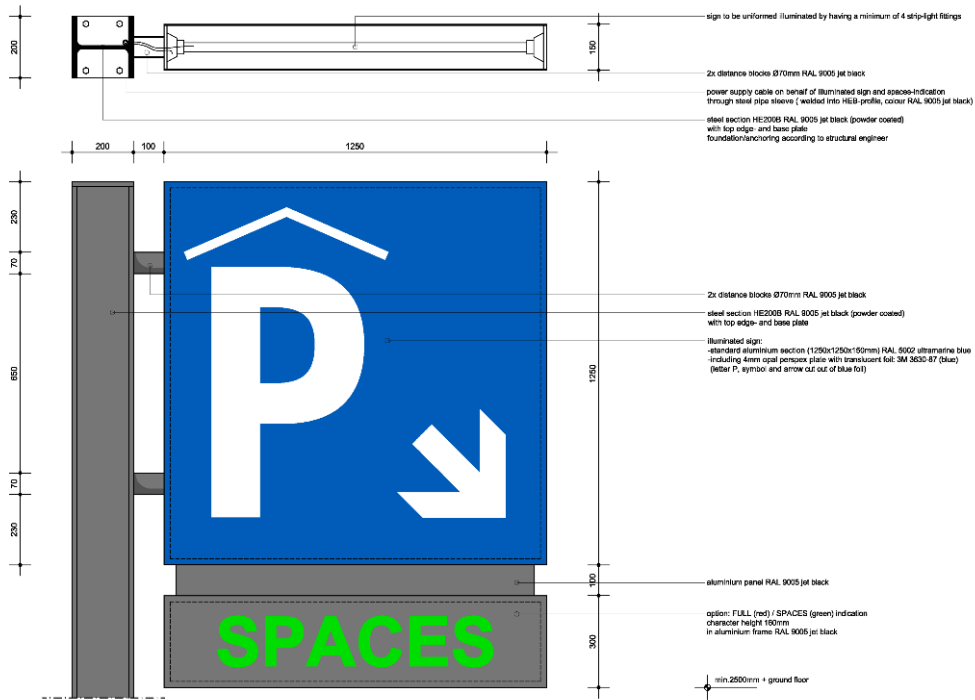

Q.01 ILLUMINATED SIGN ON COLUMN



MH1architecten

SCHAAL 1:10 - A3

DATUM 01.01.2010

DOSSIER 1986.079.02C

BLADNR. Q.01



Figure 61: Illuminated P-sign for motorists on facade

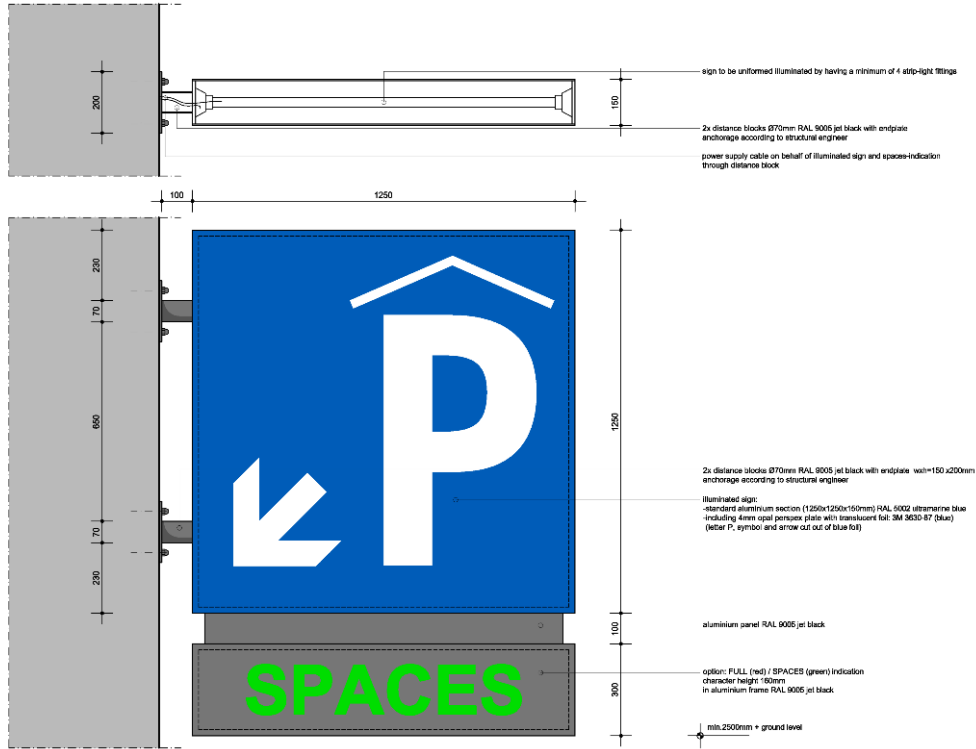

MH1architekten

SCHAAL 1:10 - A3

DATUM 01.01.2010

DOSSIER 1985.079.02C

BLADNR. Q.02



Q.02 ILLUMINATED SIGN ON FACADE

Figure 62: Illuminated P-sign for pedestrians on column

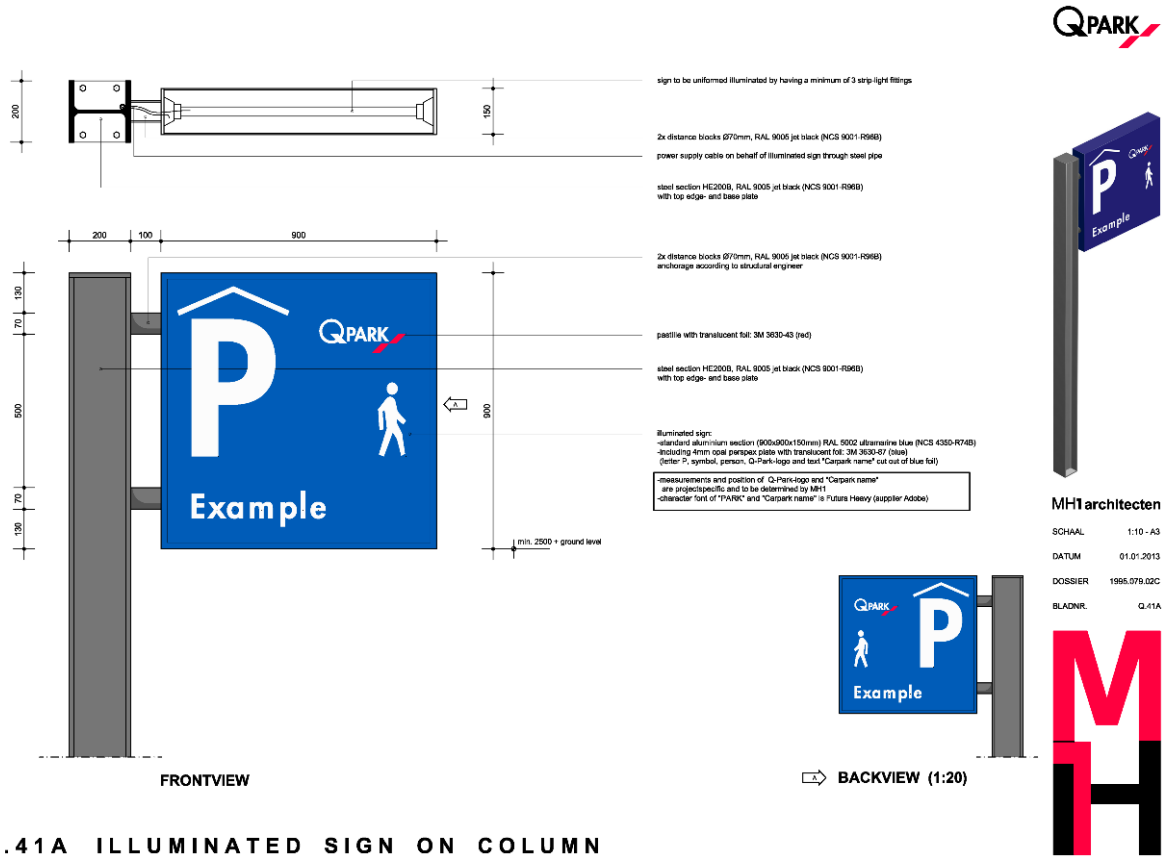

Figure 63: Illuminated P-sign for pedestrians on facade

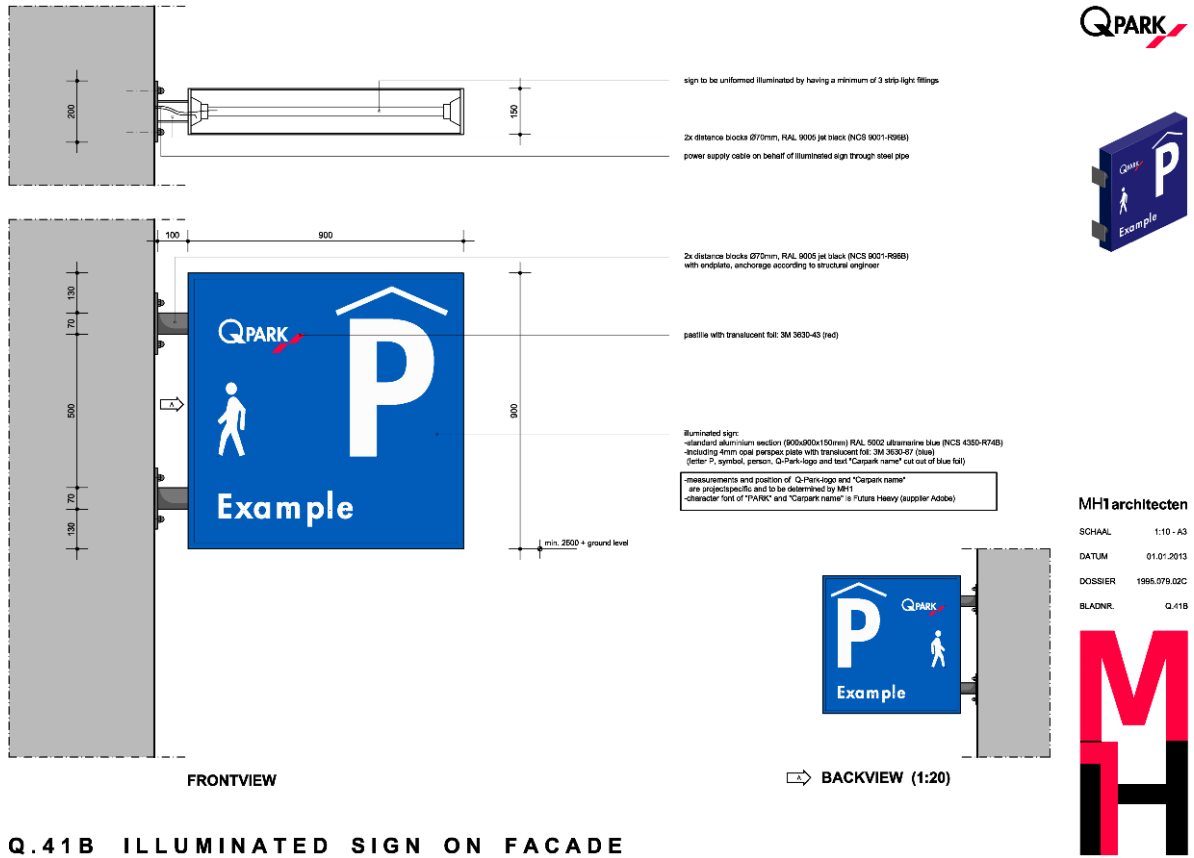
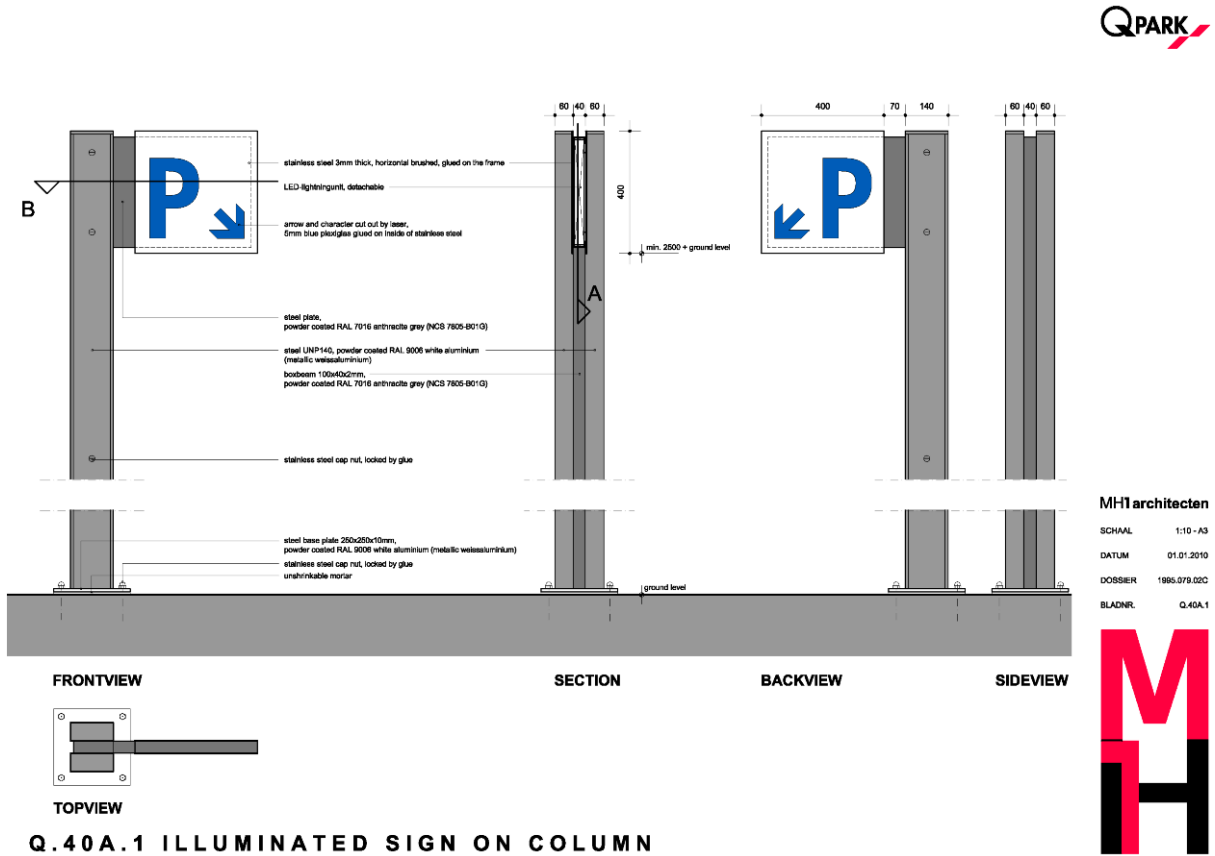

Figure 64: Illuminated P-sign for pedestrians on column, historic sites



Sandwich board / Windmaster frames

- | For use when a temporary reference to a parking facility (PF) is needed. They may be placed on-street yet local permits may be needed for placement.
- | For use when parking floors need to be closed for maintenance, cleaning or energy saving, to redirect customers.

- | Includes Q-Park logo and PF name.
- | Includes height restrictor and traffic signs (diameter 180mm).
- | Depending on the local situation, a VMS-module is integrated to show parking space availability.
- | L-shaped
- | Often used if the motorist entrance is a one-way lane only.

Visuals of boards, frames, posters - posters without 'roof' is additional costs/variables.

Portal frames - indicate the entrance to a parking facility, designed per PF.

- | U-shaped
  - | Placed at the top of the entrance for motorists.

Façade - designed per PF by CCPD and/or MH1, often consent of architect or owner of the building is required

- | When the motorists entrance is integrated in the façade of a building, the PF name is placed separately, combined with our Q-Park logo.
- | The height restrictor and traffic symbols are positioned in the façade opening.

- I Depending on the situation three options of façade signing can be applied:
  - I 1) Checkerplate with black letters;
  - I 2) Black panels with stainless steel letters;
  - I 3) Letters placed directly onto façade (stainless steel or black logo & name).  
Lighting of this type of signage is a point of attention and is possible through internally (light box) or externally placed luminaries.

### Internal signage

Internal signs for motorists and pedestrians are made of square sections.

- I Motorists: used colour is red (3M 3630-43) and the standard measurements are 300 x 300 mm.
- I Pedestrians: used colour is green (3M 3630-106) and on parking floors the measurements are 250 x 250 mm in standard situations. For measurements in staircases a smaller size of 200 x 200 mm is more sophisticated.

### Terminology

Because of the different languages used it is important that the same terminology is being applied. Where possible a different term is used for directing to the exit for pedestrians and for motorists (see list). For parking facilities in Belgium the French or Dutch language (or both) are to be used, depending on the location of the facility. Also the terms for 'parking' and 'levels' are shown in each country language.

As no parking facility is the same and each of them are located in different surroundings, the Customer Guiding System is always project specific and needs to be determined per project. Signage for motorists is almost everywhere the same, because signs for "parking", "level" and "exit" are univocal. For pedestrian signage this is different:

- I When a parking facility is not connected to any other destination and is completely solitaire, the signs for pedestrian exits should be "way out" (other country specific languages according to Figure 1). If more than one pedestrian exit is available, the addition of the street name

or location is added (respective signs #026 and #027).

- I When a parking facility is integrated in a shopping centre or an office building it is preferred to use the term "entrance" with a specific addition to increase recognisability for our customers.
- I If an exit for pedestrians leads straight to a office or shop from a third party with a recognisable brand, it is recommended to use their logo on the signs. For execution of these signs see chapter F. Signage for third party-references in Standard principles.

If parking facilities have an international character or attraction, another language can be added to the country specific language (see chapter E. Multilingual signage).

### Standard principles

- I Arrows
  - I Always make sure an arrow is pointing towards the direction of the destination for customers (pulling away from the information on the sign). The arrow-sign should be on that particular side of the sign. This makes the information on the sign more easily to read.
  - I In a situation where the arrow is pointed straight forward it is in principle positioned on the left side of the information. When a 'pulling' arrow is used in the same lane, make sure all arrows in one lane are on the same side of the information.
  - I If signage in two different directions is needed, the arrow of the left combination will be positioned on the right side of the information. This is done to make the giving information faster and more clear to read for motorists and pedestrians.
- I Assembly
  - I The typical square-shaped signs are assembled of one-module sections with an addition of 10 mm. The assembly of

longer signs is as shown in the figure below. When a sign of four sections is used, it is only combined with an arrow-sign, so no more than five sections in total are used.

- I The information giving on the signs should be carefully selected. When too much information is giving, customers will not read/see any of it. Therefore preferably no more than four sections are to be assembled at one position, pointing towards a particular location. When two, three or four sections are combined in one sign, they are mounted 10 mm apart from each other.

#### I Mounting

- I As also described in the **Procedures A and B of the Customer Guiding System, part 3.1**, it is essential to assess the concept signage-plan at the actual site. It can occur that lighting or ductwork is present, where signs are planned, or even worse, that the desired clear height is not present. Therefore the check on site is necessary and essential in designing a signage-plan.
- I In standard situations where suspended signage is used, it needs to be mounted between 2.1 metres (minimum) and 2.2 metres (maximum) above the parking floor. When the clear height for vehicles is more than 2.2 metres, the height of the signs must be adjusted to the clear height in the parking facility including an addition of 5 cm.
- I In parking facilities where, for some reason, the minimum height of 2.1 metres can not be achieved, it is possible to use ceiling mounted signs. These signs are placed under an angle of 45 degrees and are mounted onto the ceiling. By doing so a saving in height of approximately 11 cm is gained (see **Q drawing Q.32B and Figure C.2 below**).

#### I Distance

- I When information towards two different directions is needed, it is necessary to separate these two directions with an in-between distance of 10 cm.
- I Furthermore signs are repeated longitudinal with an in-between distance of 50 metres for motorists and 30 metres for pedestrians. This distance is also depending on the clear lay-out and routing of the parking facility. Regarding the amount of signs the principle 'less is more' needs to be applied. Where crucial decisions in routing are to be made, signs are needed.

- I **Again, before executing the work, a concept-plan needs to be controlled on site. This check needs to clarify if all proposed signs are correctly located and if it is possible to mount them. Also the function of the sign can be assessed by taking the surrounding signs in consideration.**

#### I Multilingual signage

- I At sites where two or more languages are to be used, an addition of a section is made. The length of the sign must not exceed five sections. If signage to services (lifts, payment equipment, lodge) is also needed it must be placed in a new sign on a second location.
- I Other services need to be displayed separately when five sections (as shown in **Figure E.1**) are already used.

#### I **Third-party signage** - see different chapter

#### I Backside of signs

- I The backside of signs is in principle used to inform customers about the routing direction. Wrong-way traffic signs are applied on the backside of these signs (**Figure F.1**).
- I When no information needs to be shown on the backside of a sign, the used colour for these signs are the same as the figures G.2 and G.3 (aluminium gray, RAL 9006).



In combination with the colour scheme of the ceilings it will result in a more calm surrounding.

#### I Bicycle signage

I It is possible that a facility for bicycle parking is integrated in a parking facility. When this occurs it is strongly recommended to have a separate elevator, ramp or stairs for entrance and exit to and from the parking facility with a bicycle. This way of accessibility should never be combined with the entrance for motorists, but can be combined with the pedestrian entrance. Facilities for bicycle parking should always be separated from parking floors to prevent customers cycling around.

I When references to certain entrances or areas to bicycle facilities are needed, it is to be combined with the pedestrian signage and is therefore in green. Bicyclists are not allowed to cycle in the parking facility and should only move around on foot. The next symbols are designed for this purpose.

#### I Usage of etch foil

I An often used house style element is the etch foil on glass doors and panels. The underlying thought for usage of this etch foil is that it is applied on fully glazed doors and panels, where customers might overlook the glass and by mistake walk into it. To make a difference between doors and panels, the 'QPark'- logo is to be applied on glazed doors and the 'striping' is applied on glazed panels.

I The etch foil is not to be applied on every part of glass in a parking facility. Only where glass panels from floor to ceiling are used and where there is the safety issue that customers walk into it by mistake.

I Some examples:

I The glass in the lodge of the Parking Host, above the checkerplate, is no area where people might walk into, so no etch foil is to be applied.

I Fully glazed door in a public area is to be provided with a 'Q-Park' logo in etch foil;

I Fully glazed (floor to ceiling) walls around a pedestrian entrance or near the lodge are to be provided with the etch foil 'striping'.

When a service for bicycle parking is integrated in a parking facility, always contact Q-Park Holding for the design and location of the facility and entrances.

## Housestyle elements

For the recognition of the Q-Park Brand, several house style elements are integrated in the parking facilities. Implementation of these elements are always part of the project specific documents, provided by MH1.

### Checkerplate wall

At the entrance or exit of the parking facility a checkerplate wall can be implemented to give the customer a first or final impression of the location. It is used to display the Q-Park logo and the name of the parking facility. A blue light line is added to increase the visibility and create an ambiance at the entrance and exit area.

### Guiding elements

In order to guide customers or to prevent possible accidents guiding elements in different forms can be used.

I Drawing Q.12A This element is used to guide customers in cars into the right direction. It is very often used at the entrance and exit area to divide driving aisles from pedestrian areas. A blue light line is integrated to increase visibility.

- I Drawing Q.12B If traffic in two directions is to be expected a square-boxed guiding element can be placed.
- I Drawing Q.12C If parking spaces are projected in front of glass walls, these walls can be protected by placing a round galvanised guiding rail.

### **Litter bin**

In order to attract extra attention to the pedestrian entrance of a main staircase, the door is highlighted by a level indicator and a litter bin. Every pedestrian exits and enters the parking floor through these doors and to prevent litter from being left behind, several litter bins are to be implemented on these locations.

### **Stainless steel pole**

When motorists are not allowed to park their car in a specific place due to safety reasons, the space can be marked with brushed stainless steel poles. Also pedestrian zones can be marked with these poles. It is important that these poles always have the same appearance and no fences are used because of the obstruction they cause for pedestrians. Therefore measurements have to be the same, being approximately: height = 1,000 mm; width = Ø105 mm; footplate = Ø150 mm.

# PARTNERSHIP SIGNAGE

We welcome partnerships who offer relevant services in our parking facilities. We acknowledge the importance of their house style appearance. However, in our 'house', the Q-Park house style is leading. But we do provide our partners with opportunities to integrate their way finding, **retail (office space) recognition** and advertisement signage in our house style.

In this chapter:

- I Signage
  - I External guidance
  - I Internal guidance
  - I Parking space(s)
- I **Alternative use space(s)**
- I Media integration
  - I Onsite poster frames
  - I Onsite tariff posters at access points

- I Onsite advertisement panels
- I Online website(s)
- I Online app(s)
- I Other conditions
- I Internal process

In the process of composing/signing the contract or (sub)lease with partners, there needs to be a sign-off by Q-Park Commercial Leads and a design sign-off by Corporate Real Estate.

## Signage

### External signage

Partner logos are kept to a minimum as motorists should not be distracted. No additional information such as websites, phone numbers et cetera are allowed.

## Mobility Hub external signage | car entry

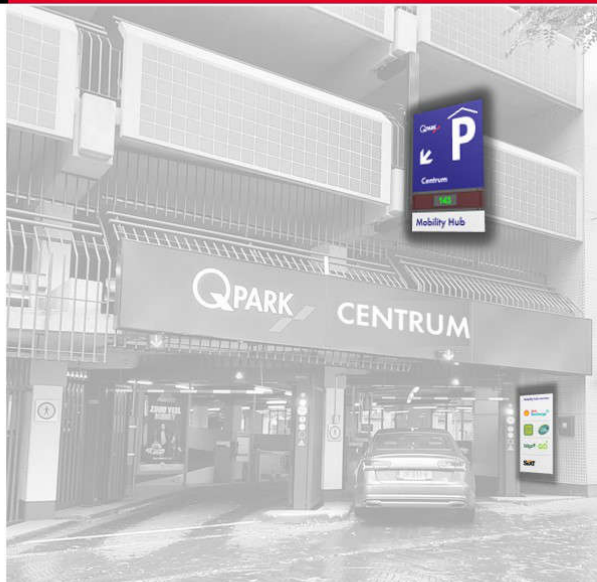

- I Blue flag-sign: Q-Park house style + "Mobility Hub" text box added
- I Mobility hub panel: Full colour logo's of of service providers:
  - I At eye-catching areas
  - I Subject to planning permissions & pre-cario regulations
- I Service provider logo's on light grey panels
  - I According to "Third-party"-signage principles

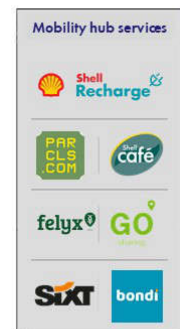

## Mobility Hub external signage | on-street



- I Blue flag-sign: Q-Park house style + "Mobility Hub" text box added
- I Mobility hub panel: Full colour logo's of service providers
  - I At eye-catching key areas / At specific service entrances
  - I Subject to planning permissions & pre-cario regulations
- I Service provider logo's on light grey panels
  - I According to "Third-party" signage principles

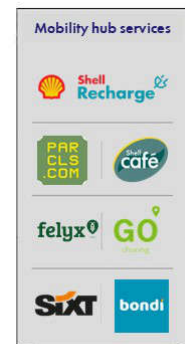

© Q-Park 2022 10

### Internal signage

- I Partner logo can be incorporated on a light grey Dibond sign attached to a typical Q-Park directional arrow sign (red for motorists and green for pedestrians).
- I Signs have to be installed by Q-Park's local signage contractor who has the measurements and technical specifications of that particular site available.
- I The number of signs are kept to a minimum and all positions have to be approved by Q-Park prior to installation.

To integrate the style of a third party in our house style, it must be applied as followed: The used material is a standard aluminium plate or the standard Dibond plate (RAL 9006). The printable area is 35 mm smaller on each side with a sign of 300 x 300 mm. **(What about double sizes?)** Other measurements need to be scaled from this ratio. A sign of 250 x 250 mm has a edge distance of 30 mm.

## Internal routing: at entry barriers



- Mobility Hub totem
- Full colour logo's of service providers
- Include level indications

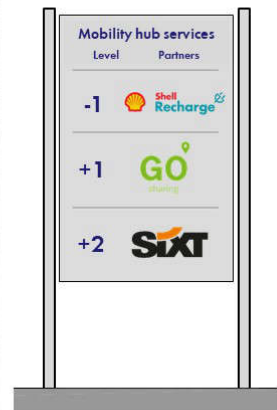

© Q-Park 2022 12

## Internal routing: routing / wayfinding

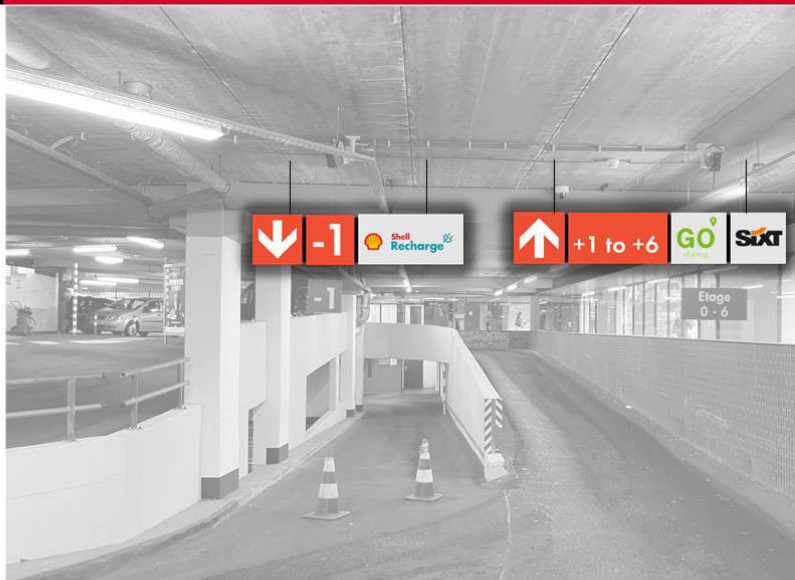

- Principle wayfinding signs in red
- Primary objective is parking customer wayfinding!
- Service provider logo's on light grey signs
- According to "third-party"-signage principles
- Only at critical routing decision points



© Q-Park 2022 13

Photo example motorists - single and double size templates + example

Photo example pedestrians - single and double size templates + example

## Parking space(s)

Partner logos can be located above or at the back of a parking space. The measurements of these signs are usually 300 x 300 mm.

### Photo example parking space

## Alternative use space(s)

Wall and floor colours have to be respected. In case new finishes will be applied and/or company logos are needed to emphasize the third-party function, a design sign-off by Corporate Real Estate is required.

## Media integration

### Onsite

1. Partner poster: advertisement by means of A1 posters is possible using dedicated Q-Park A1 poster frames, provided for and planned by marketing. Sign-off of poster design by marketing is required.
2. Partner services: integration of services offered on Q-Park Prices & Services poster(s) at access points and payment machines is possible after consultation and approval by marketing.  
**Photo example(s)**
3. Advertisement panels
  - a. Placement of advertisement: please contact the relevant advertising company.
  - b. Location of panels:
    - i. Careful selection is necessary as they may not hinder our customers. Location proposals must be signed-off by Corporate Real Estate.
    - ii. Do not position near access and exit points of motorists.
    - iii. **Barrier panels are not allowed** as they interfere with our parking technology
    - iv. We work with preferred suppliers and media partners. Country consistency is required with one style of frames and

panels, according to Q-Park housestyle principles.

- v. Every new contract proposal (per parking facility) is based on a physical visit by at least the media partner and Q-Park operations, preferably accompanied by Real Estate and Marketing.
- vi. A maintenance programme needs to be integrated in the contract and has to involve:
  - | routine maintenance activities
  - | rapid response service
  - | safety and preventive maintenance activities
  - | inspection and quality control
  - | customer service and complaint handling
- vii. Highest quality products
  - | Both static and dynamic panels need to be constructed with the best-tested and reliable parts.
  - | Casings need to be suitable for its environment.
  - | Casings are made of aluminum and will be powder-coated in the desired Q-Park colour.
  - | Glass must be toughened or layered safety glass.

### Online

1. Partner services website: integration of services offered on Q-Park website(s) is possible after consultation and approval by marketing.  
**Photo example(s)**
2. Partner services app:

### Other conditions

Lighting: the type and method of connection to the electrical installation is to be agreed up front and has to be performed by an official electrical contractor to

ensure a labelled and quality connection. Also, if energy consumption will need to be measured and invoiced separately, this has to be part of the contract.

Water and drainage: in case water is needed, a proper organisation of collecting water is required. Slip hazards have to be prevented at all times. Responsibilities have to be stated clearly in the contract.

End of contract

- | The contract between Q-Park and a third party should always include a clause on restoring the location in its original state.
- | Confirmation and agreement from both parties is essential on who is responsible for the various elements such as signage, technical installations, ...

### Internal process

To finetune the process of acceptance and/or contract negotiation with a third-party, the following departments are involved:

- | Country organisation: Asset Management, Sales & Marketing, Operations
- | Group organisation: Corporate Real Estate, Corporate Brand

### Organisation chart

# EV-CHARGING POINTS MANUAL

## External signage

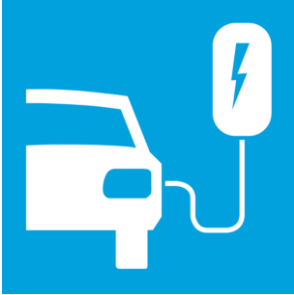

Icon code 119d

### Application:

- | Optional, unless required by local regulations

### Specifications:

- | Panel:
  - | Panel picto (180x180mm) on plate (160x160x10mm) RAL9005 jet black
  - | Dibond plate (2mm) ([www.Dibond.eu](http://www.Dibond.eu)), platinum white (~RAL9016) matt
  - | Foil on plate: 3M 3630-57 olympic blue / Oracal 8500-53 light blue
  - | Signage cut out of blue foil
- | Dimensions:
  - | Height = 180mm
  - | Width = 180mm
- | Q-drawings:
  - | Q.03.1 Entrance portal U-shape
  - | Q.04.1 Entrance portal L-shape
  - | Q.05.1 Name indication facade



Entrance portal U-shape

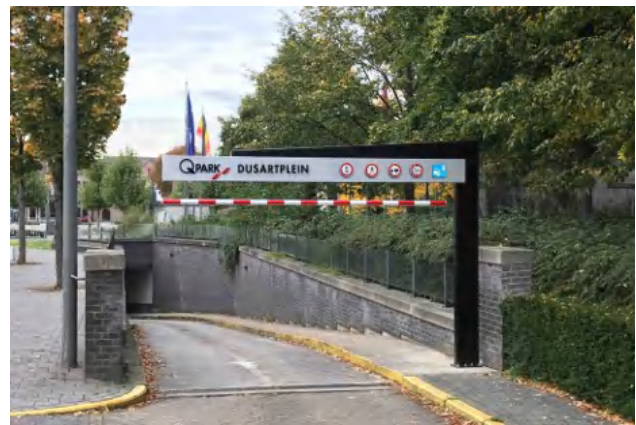

Entrance portal L-shape



Name indication facade



## Internal signage routing

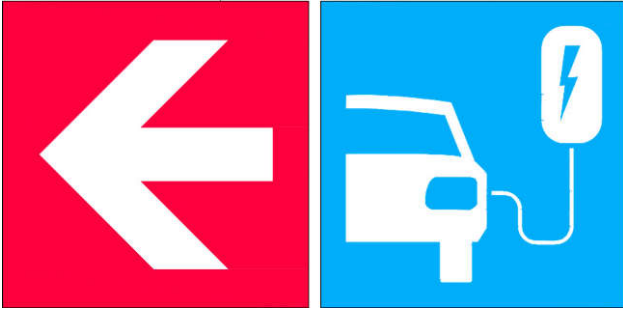

### Application:

- | Signage on the route to EV-charging, only mounted at key decision points (EV-charging sign in blue foil)

### Specifications:

- | Panel:
  - | Panel (double-sided) glued on 18mm wbp plywood, at lateral side & joints plywood painted RAL9005 jet black
  - | Dibond plate (2mm) ([www.Dibond.eu](http://www.Dibond.eu)), platinum white (~RAL9016) matt
  - | Foil on plate:
    - | 3M 3630-43 Light tomato red (for arrow sign)
    - | 3M 3630-57 olympic blue / Oracal 8500-53 light blue (for EV-charging sign)
  - | Signage cut out of red and blue foil
- | Dimensions:
  - | Height = 300mm
  - | Width = 300mm
- | Q-drawings:
  - | Q.30.1 Position of signage
  - | Q.32.A Signage, suspended
  - | Q.32.B Signage, mounting on ceiling

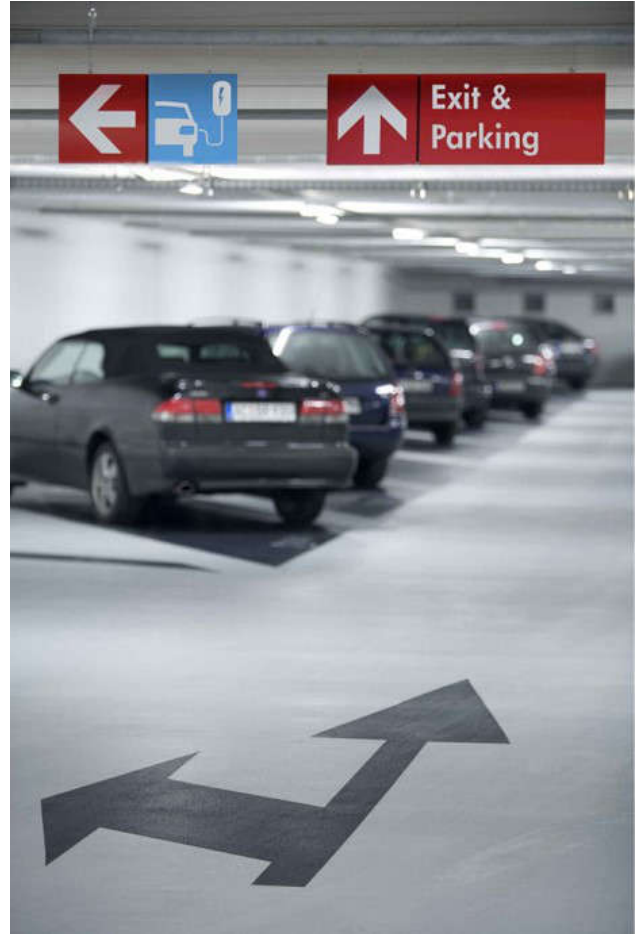

### Premium

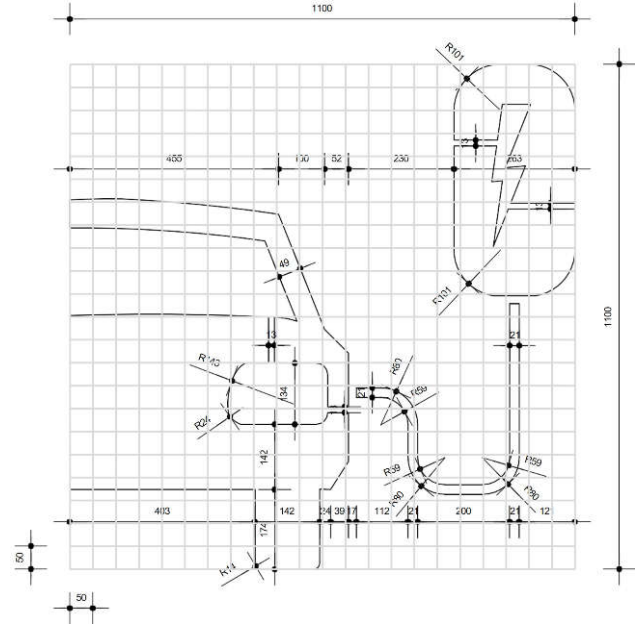
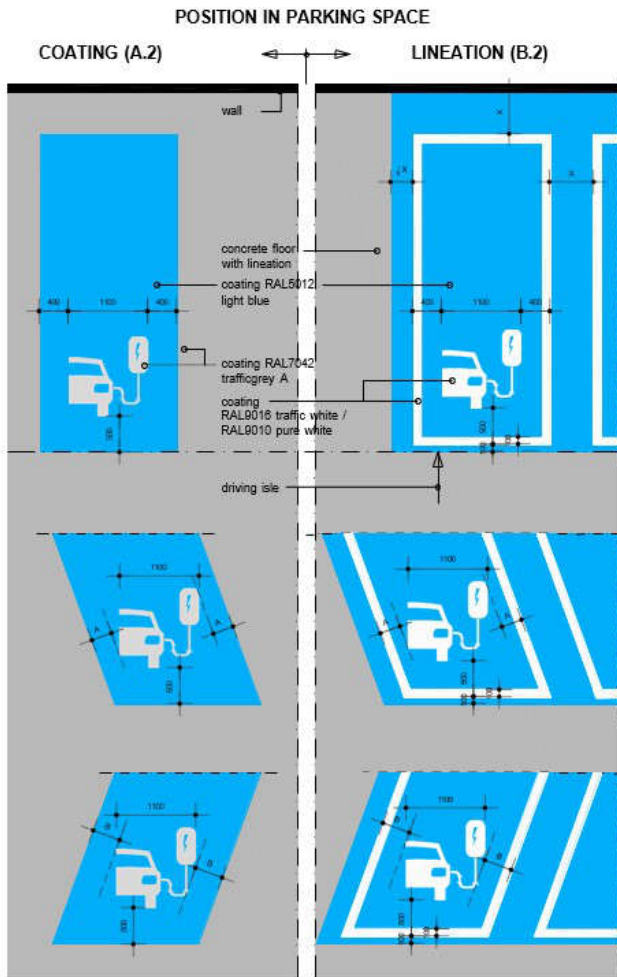

Title



## Internal signage at EV-charging points

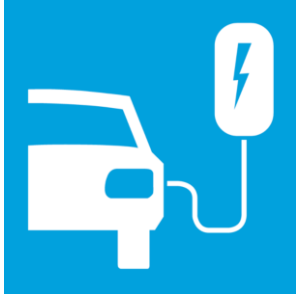

Front and rear equal sign, double-sided (see also floorplan)

### Application:

- I Signage EV-charging suspended perpendicular to driving aisle for visibility
  - I Position aligned with front of parking space at heart of a single space
- I EV-charging device (wall mounted), colour reference neutral light colour
  - I Position always between parking spaces and never at heart of a single space
  - I Bottom of EV-charging device at 800mm+floor
  - I Power supply via ceiling

### Specifications:

- I Panel:
  - I Panel (double-sided) glued on 18mm wbp plywood, at lateral side & joints plywood painted RAL9005 jet black
  - I Dibond plate (2mm) ([www.Dibond.eu](http://www.Dibond.eu)), platinum white (~RAL9016) matt (double-sided)
  - I Foil on plate: 3M 3630-57 olympic blue / Oracal 8500-53 light blue (double-sided)
  - I Signage cut out of blue foil
- I Dimensions:
  - I Height = 300mm
  - I Width = 300mm
- I Q-drawings:

- I Q.32.A Signage, suspended
- I Q.32.B Signage, mounting on ceiling

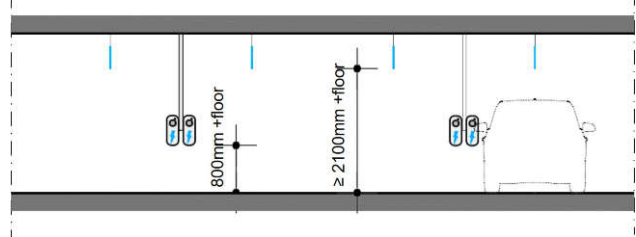

Section

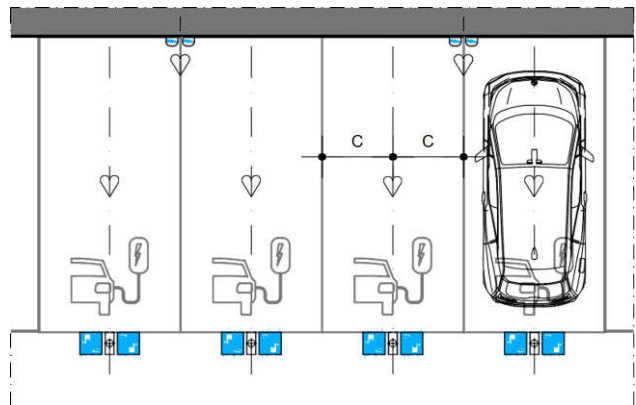

Floorplan

## Internal signage at EV-charging points (A1-frame)



### Application:

- | A1-frame (wall mounted) for communication EV-charging
- | Position always between parking spaces and never at heart of a single space
- | Minimal 1x A1-frame per 4 CPs where CPs are located

### Specifications:

- | A1-poster:
  - | Poster size: height x width = 832 x 593mm
  - | Poster layout: CPO branded & mandatory information:
    - | Clear CP usage instructions (start/start session, unplug etc.)

- | CPO customer helpdesk phone number and e-mail
- | Tariff information reference (where to find charging tariffs?)
- | Location of the specific charge point ID (reference number)
- | Explain functionalities (indicator/display colours)
- | Optional subtle co-branding with Q-Park (not preferred)

### Dimensions A1-frame:

- | Height = 924mm
- | Width = 690mm

### Q-drawings:

- | Q.33.B Signage A1-frame, wall fastening

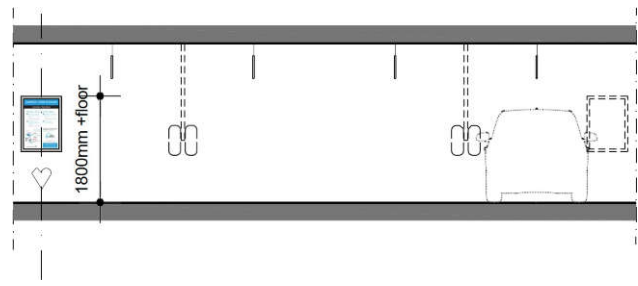

Section

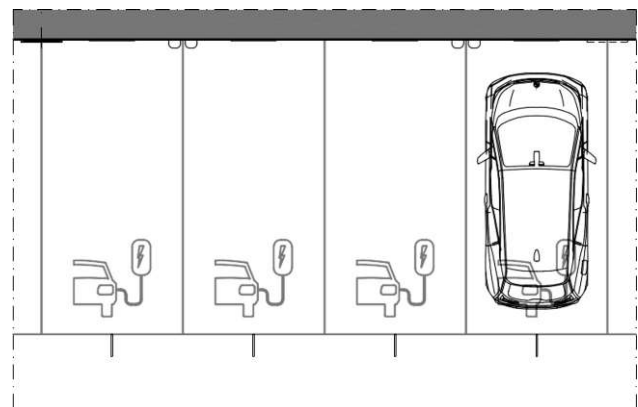

Floorplan

## Internal signage at EV-charging points (optional signage)

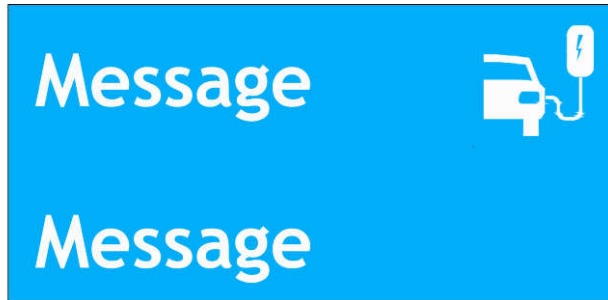

Example

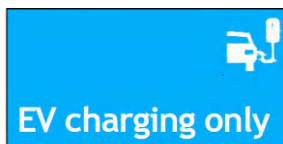

Example

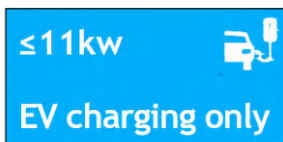

Example

### Application:

- | Only applicable in case legally binding message is needed
- | In order to distinct regular CPs (AC < 11 kW) with fast CPs (DC > 22 kW) where applicable
- | Sign preferably wall mounted (top of sign = top of A1-frame)
- | Position always at heart of the EV-charging space
- | 1 sign per parking space

### Specifications:

- | Panel:
  - | Panel (single-sided) glued on 18mm wbp plywood
  - | At lateral side and joints plywood painted RAL9005 jet black

- | Dibond plate (2mm) ([www.Dibond.eu](http://www.Dibond.eu)), platinum white (~RAL9016) matt
- | Foil on plate: 3M 3630-57 olympic blue / Oracal 8500-53 light blue
- | Signage cut out of blue foil
- | Dimensions:
  - | Height = 300mm
  - | Width = 610mm
- | Q-drawings:
  - | Q.33.A Signage, wall fastening

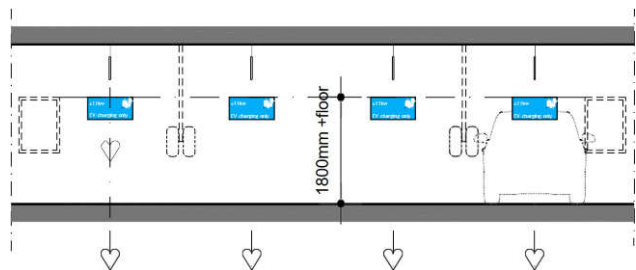

Section

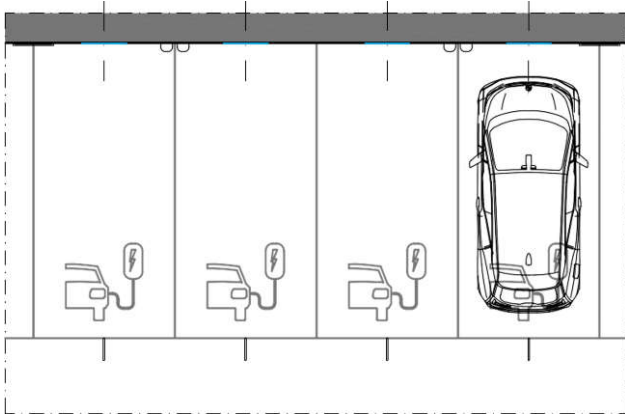

Floorplan

## Floor markings at EV-charging points

### Standard

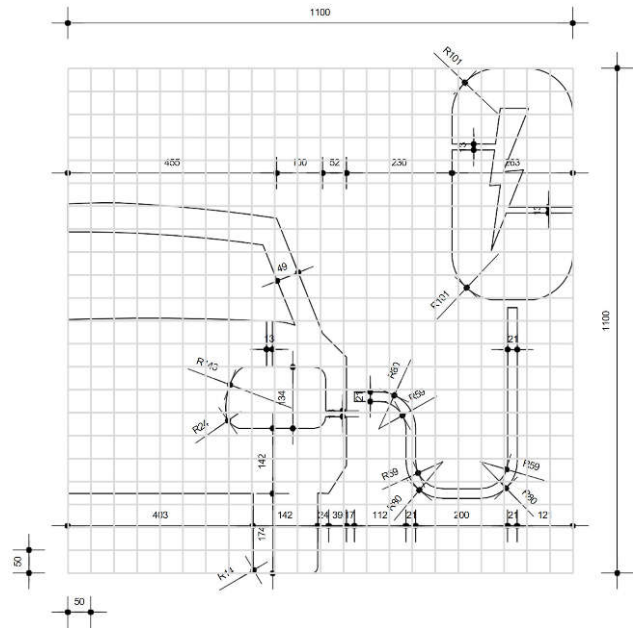
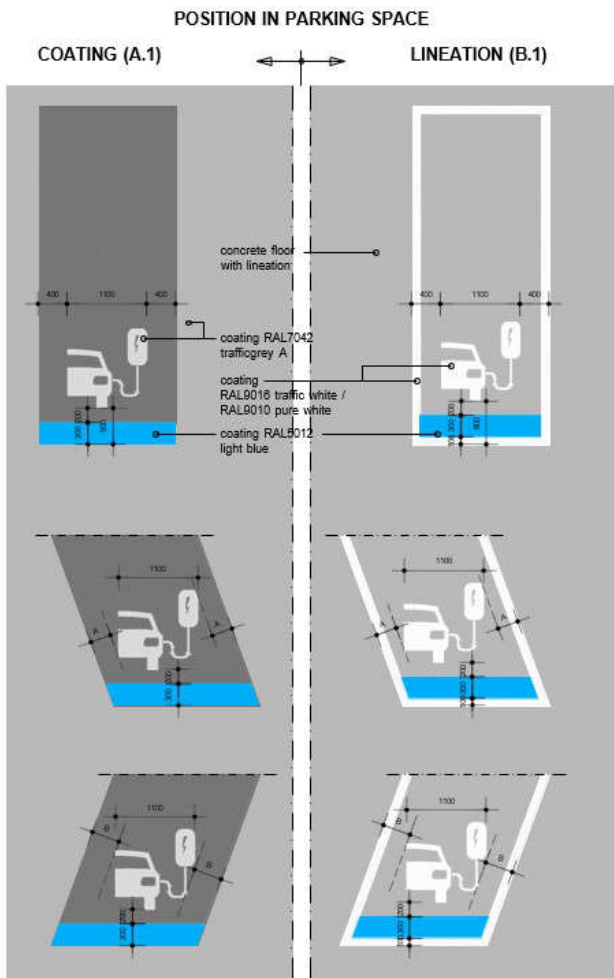

# MOBILITY HUB SIGNAGE MANUAL

## Content

### 1. Introduction

### 2. Vehicle Entry

### 3. Pedestrian Entrance

### 4. Services

- I 4A. Communication **OF** services
  - I Vehicle entry - outside/inside
  - I Pedestrian entrance - outside/inside
  - I Micro mobility entry - outside/inside
- I 4B. Wayfinding **TO** services
- I 4C. Information **AT** services

### 5. Specials

- I Building fragments facade

### 6. Appendix

- I QP-drawings

## 1. Introduction

This manual describes the guidelines that apply to *Mobility Hub Signage*. These guidelines are part of our house style and should be seen in conjunction with and as an addition to our existing house style and signage. This manual specifically describes and focuses on *Mobility Hub Signage*.

This manual primarily uses examples that serve as guidelines to support the implementation of this additional signage on site. In case of questions or suggestions, please contact Corporate Real Estate (CRE).

#### Q-Park Mobility Hubs:

The Q-Park mobility Hub is part of our sustainable Mobility Partner programme (SMP). The SMP programme aims to transform Q-Park from a parking operator to a sustainable Mobility Hub partner. We do this with recognisable Mobility Hub.

To qualify as a Mobility Hub, at least 4 services are offered:

- I Parking services
- I Charging services
- I Booking (transforming search traffic to destination traffic)
- I Sharing (cars, scooters, bicycles) from the Mobility Hub, or public transport services available within a radius of at least 300 meters from the parking facility (train, bus, metro)

## 2. Vehicle Entry

The reference to the Q-Park vehicle entry has various appearances. The starting point is that the text Mobility Hub is clearly communicated only once at the entry. We prefer to use the existing P-sign for this purpose. Once 'Mobility Hub' has been added to the P-sign, it does not need to be added elsewhere (such as on L- or U-shaped portals).

Hereafter are a number of appearances of P-signs where Mobility Hub has been added or integrated:

- I Illuminated P-sign on column
- I Illuminated P-sign on facade
- I Entry portal (U-shape) including P-sign frontal
- I Entry pillar/totem with P-sign

### Illuminated P-sign on Column

There are two options:

- I Preferred solution:  
Separate module Mobility Hub under P: It is preferable to position Mobility Hub, as a separate

module, directly under the P. In case module with space indication is present, Mobility Hub should always be placed directly under the P, with below the module with space indication.

According to drawing QR01A.1 and QR01A.2



Preferred solution without space indication



Preferred solution with space indication



- I Alternative: Mobility Hub integrated in P-sign: The existing layout (square) should be adjusted to layout (square) incl. Mobility Hub. Only if the preferred option is not possible or too complex (e.g. Due to limited height under the P or module), this alternative may be applied
- According to drawing QP.01B.1 and QP.01B.2



Alternative solution with space indication

### Illuminated P-sign on facade

There are two appearances here:

- I P-sign frontal in facade: The same principles apply as for the entry portal (U-shape)

- I P-sign perpendicular to the facade: the same principles apply as for the illuminated P-sign on column



P-sign frontal in facade



P-sign perpendicular to the facade



## Entry portal (U-shape) including P-sign frontal

There are two appearances:

- I Entry portal with separate grey picto-bar: the text Mobility Hubs is applied to this grey picto-bar.

No specific QP-drawing has been made for this situation, as the 'adding' of the text 'Mobility Hub' depends on the available space, which can differ per situation. The text is executed in the font FuturaTDem (supplier Adobe), colour daek bloe Oracal 8500-049 king blue (on an existing silver-grey or light-grey background), aligned left-right with the P.



- I Entry portal without separate grey picto-bar: the existing P-sign layout (square) must be adjusted to

layout (square) incl. Mobility Hub centered within the square.



### Entry pillar/totem with P-sign

The text Mobility Hub is positioned directly under the P-sign. There is normally sufficient space under the P-sign. If space is lacking, the text can be placed lower.

No specific QP-drawing has been made for this situation, as the 'adding' of the text 'Mobility Hub'

depends on the available space, which can differ per situation. The text is executed in the font Futura TDem (supplier Adobe), colour dark blue Oracal 8500-049 king blue (on an existing silver-grey or light-grey background), centered on the panel.



### 3. Pedestrian Entrance

The reference to the Q-Park entrance pedestrians has many appearances where the P-sign often has limited dimensions. With some exceptions, we therefore advise not to add Mobility Hub to or integrate it into the existing P-sign.

However, we prescribe to apply the text Mobility Hub in etchfoil to entrance doors, according to drawing QP.31 as attached to this manual.

In addition, there are often designated positions at this location to communicate the mobility hub services (on the outside or directly near the entrance): see 3A: Communication of services.



#### 4. Services

It is important to effectively communicate the Mobility Hub services at the appropriate locations (communication of services). The vehicle entry, the pedestrian entrance and a (possible) exclusive micro mobility entry are the designated positions for this.

From these entries / entrances, the signage must clearly and accurately refer to the services (wayfinding to services).

If necessary, services will also be communicated at the locations itself (information at services).

## 4A. Communication of services

### Vehicle entry outside/inside

If space is available, services should be communicated on the outside. Inside, there is often space to provide an extra A1-frame on a traffic island (or against a wall). For this purpose, a standard layout should be applied as the principles shown in the images above.

For the entry outside, the dimensions may differ (from A1-format) in connection with the readability from a greater distance. If there is sufficient space, a larger frame or panel with the same layout can be used to enhance visibility.







### **Pedestrian entrance outside/inside**

In principle, the same applies to the pedestrian entrance as to the vehicle entry: If space is available, services should be communicated on the outside. Inside, there is often space to provide an (extra) A1-frame on a wall or between two stainless steel uprights. The same standard layout should also be applied in these places as the principles shown in the images above.

For the pedestrian entrance, the dimensions may differ (from A1-format) in connection with the readability from a greater distance. If there is sufficient space, a larger frame or panel with the same layout can be used to enhance visibility.

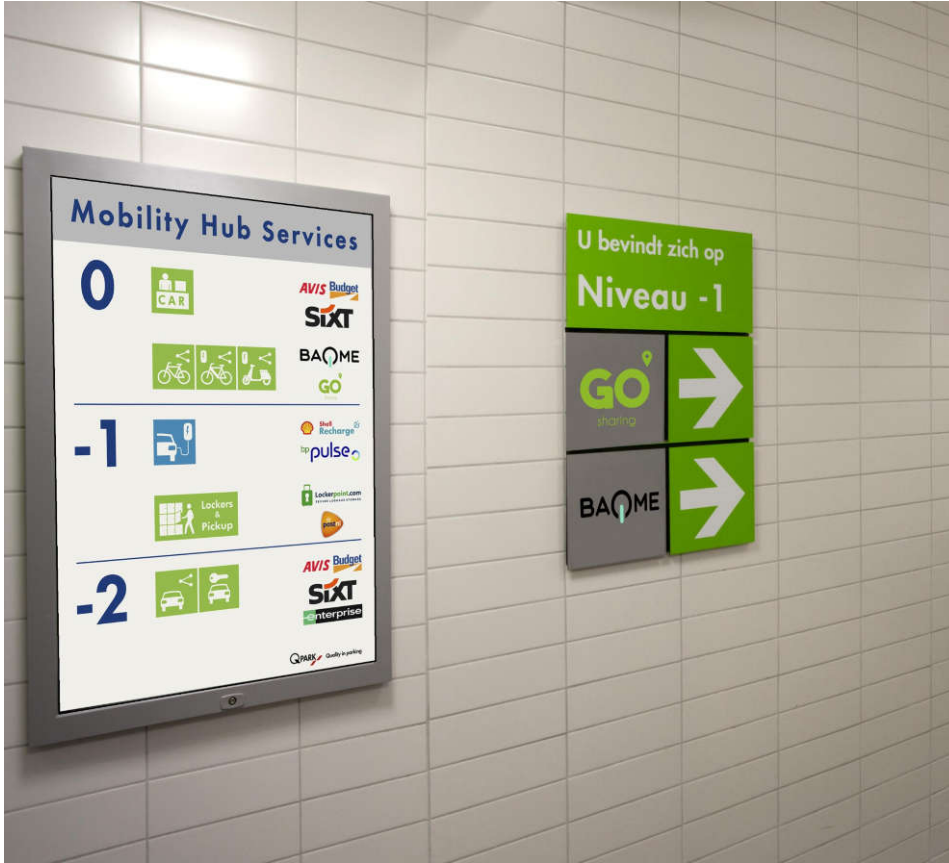



### Micro-mobility entry outside/inside

The micro mobility or bicycle parking entry usually has a separate entry (to prevent different traffic flows from coming together). If this service is part of our facility, the entry should also be recognized as such on the outside.

In that case, a light box with the pictogram of the service(s) (bicycle parking or more), the name of the

facility and the Q-Park logo should be provided. Since these situations will never be 'standard', it is advisable to ask CRE for advice.

This also applies to the entry inside (if this entry does not provide direct access to the bicycle parking).



#### 4B. Wayfinding to services

The wayfinding to services, both for vehicles and pedestrians, is expressed in our house style signage which, in many cases, must be seen in conjunction with the existing signage in a facility.

The 'adding' of the signage for services should be done by means of pictograms and/or using logos. If logos (of service providers) are used, these logos are applied

on a silver-grey background which also applies to other logos (supermarket, retail chain, hotel etc.).

If (our standard) pictograms are used, these are (in principle) green - white (this is standard for all services except charging which is blue - white).

If the above gives rise to questions (for a specific project), please contact CRE.





#### 4C. Information at services

##### EV Charging

The signage for the EV-charging service (regular / AC charging) must be carried out in accordance with the 20230414 - Q-Park EV-charging points manual.

If fast / DC charging is offered as a service, the signage is usually done by an external service provider (e.g. Shell, BP). In that case, logos are provided on a silver-grey background. It is also possible that the surface of these parking spaces/charging points is in a different colour and is provided with a logo (subject to approval by Q-Park).

**Car rental**

The service for car rental and/or car sharing is often 'represented' by an office/counter and the zone where the vehicles are parked.

The office or counter of the service provider is often located in the plinth of the building (MSCP) or near the zone where the vehicles are parked. These spaces

may fully reflect the provider's house style in terms of appearance, subject to approval by Q-Park.

The signage at the location of the zone where the vehicles are parked is part of the house style of Q-Park, whereby pictograms and/or logos should be used.



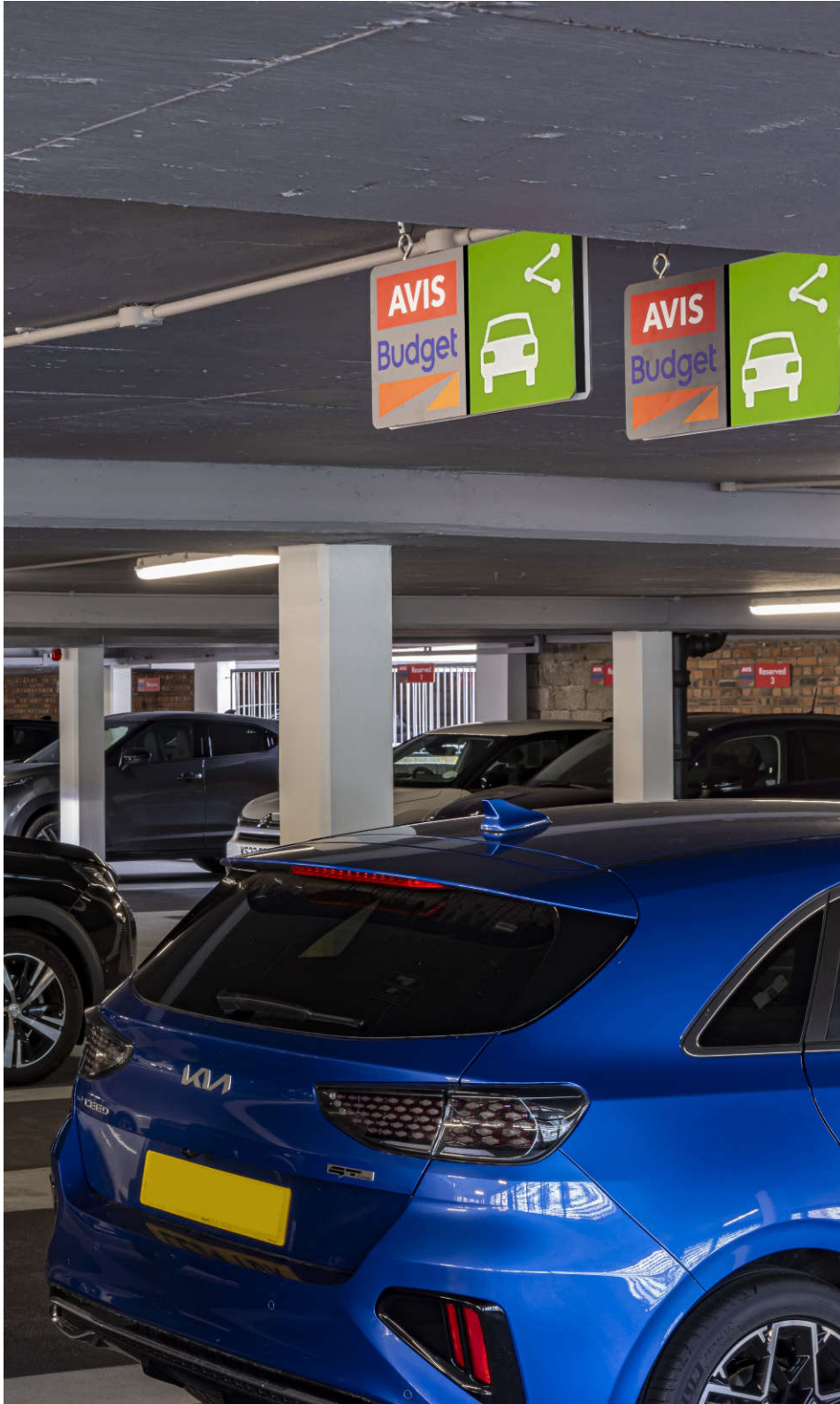



### Micro mobility

The micro mobility or bicycle parking should be a separated zone with a separate access that is located next to or in the parking facility (see also 3A. communication of services).

If this zone is part of the parking facility, it is desirable to implement the (storey-high) separation in a transparent fence. Depending on the type of two-wheelers, (extra)

markings are required on the surface. Please seek advice from CRE regarding accessibility, choice of materials, colour scheme and any (possible) floor markings to be applied.

The signage at the location of the zone is part of the house style of Q-Park, whereby pictograms and/or logos should be used.



**Public transport (train, bus, metro)**

Public transport (train, bus or metro) is usually not part of our facility but usually 'connected' to our facility (via corridor, tunnel or bridge) and otherwise in the direct vicinity of our facility.

The signage 'at the service' in this case is therefore the signage of the train, bus or metro station itself and therefore in its own house style or brand.

However, it is important that Q-Park clearly and distinctly refers to these means of public transport in its facility so that users can easily reach and find this service/destination. This (pedestrian) signage is part of our house style where pictograms and/or logos (e.g. national railway logo) should be used.



### Parcel service / pickup points / lockers

For services such as parcel delivery, pickup points and lockers, determining the optimal location within an

existing facility is essential to ensure users can easily find an access them.

If the above has been fulfilled, the signage at these services themselves is simple: the signage is part of the house style of Q-Park, whereby pictograms and/or

logos should be used. Often these services are easily recognisable (provided with logos) so that additional signage is not necessary.



## 5. Specials

There will always be special locations or circumstances where it is desirable to have 'Mobility Hub' expressions on or in the building.

These specific and special situations are not described in this manual. Please contact CRE so that a suitable solution can be worked out together.

On the following two pages, suggestions have been made, for illustrative purposes, to make this 'Mobility Hub' expression clearly visible on facade fragments.

### Building facade fragments



## 6. Appendix

### QP-drawings

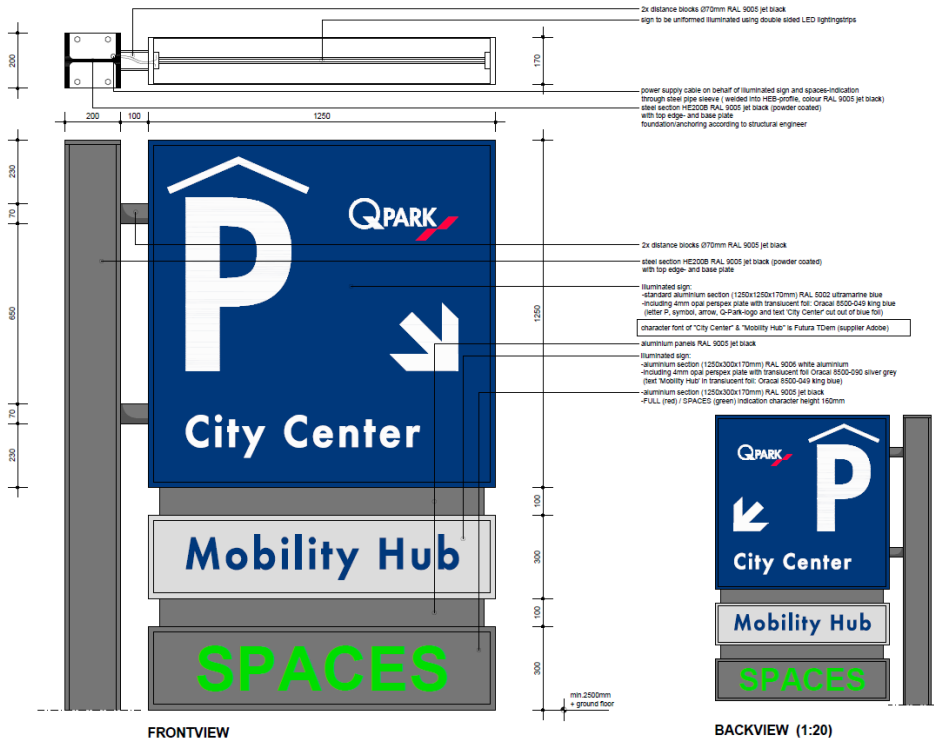

QP01A.1 Illuminated sign on column - Mobility Hub

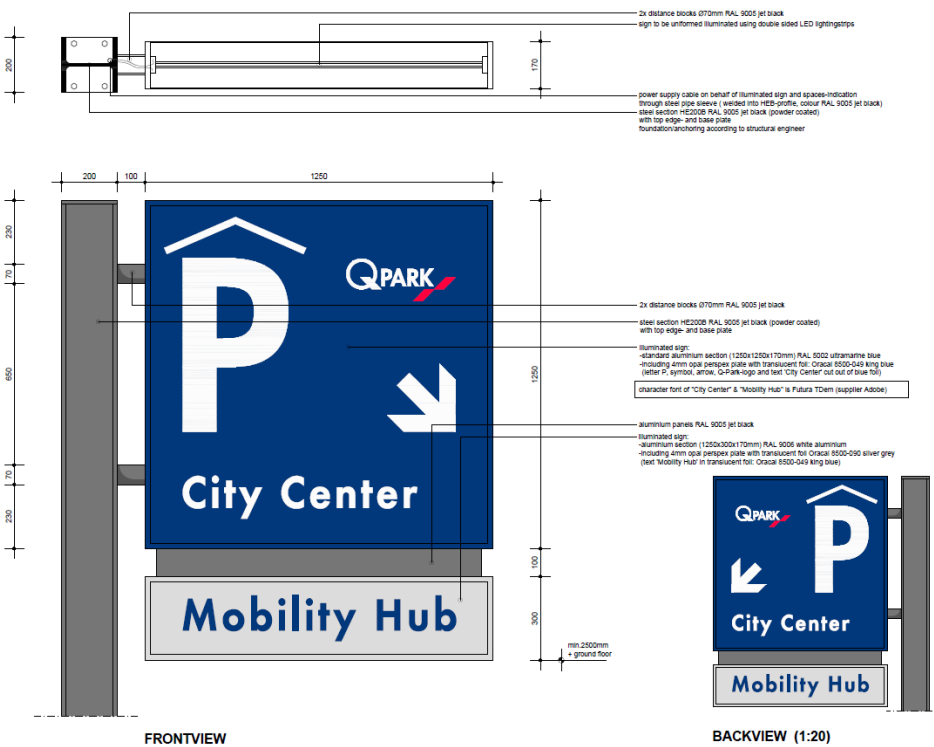

QP01A.2 Illuminated sign on column - Mobility Hub



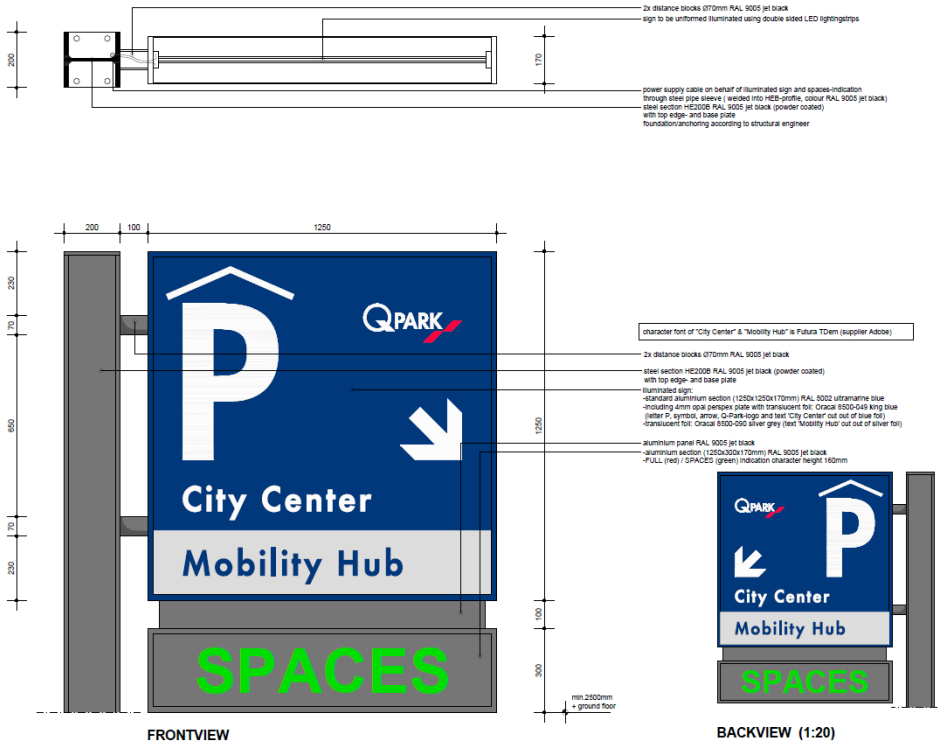

MQ01B.1 Illuminated sign on column - Mobility Hub

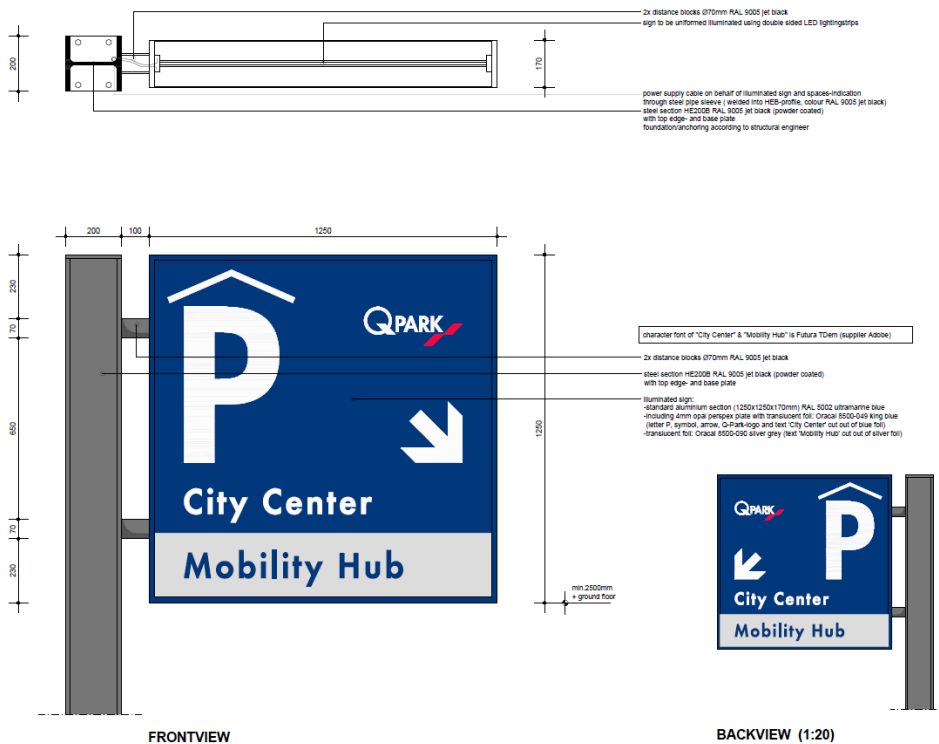

MQ01B.2 Illuminated sign on column - Mobility Hub

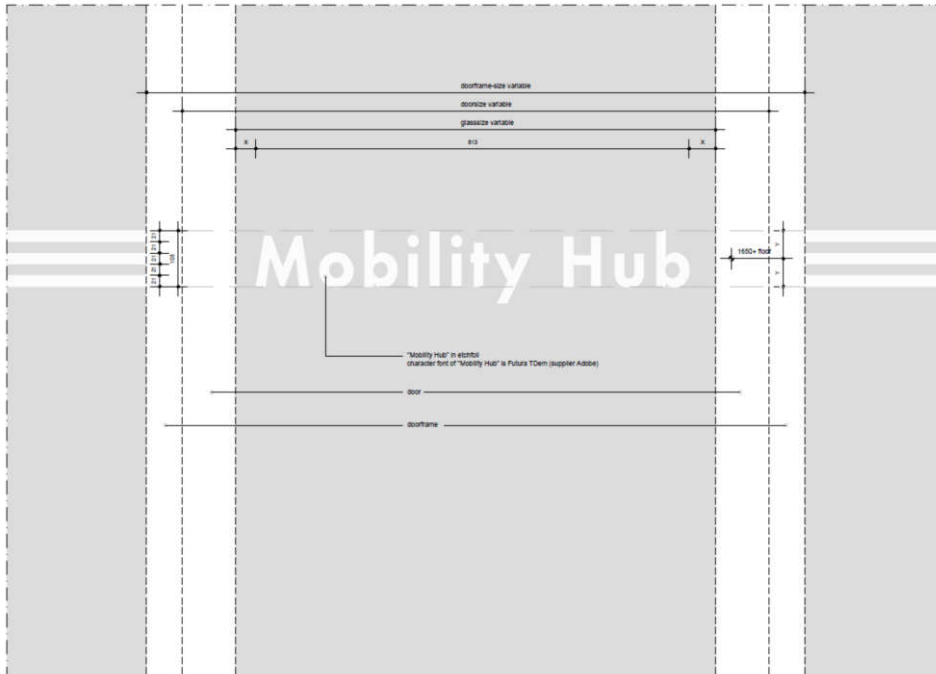

QP.31 Principle etchfoil - Mobility Hub

QP-drawings (France)

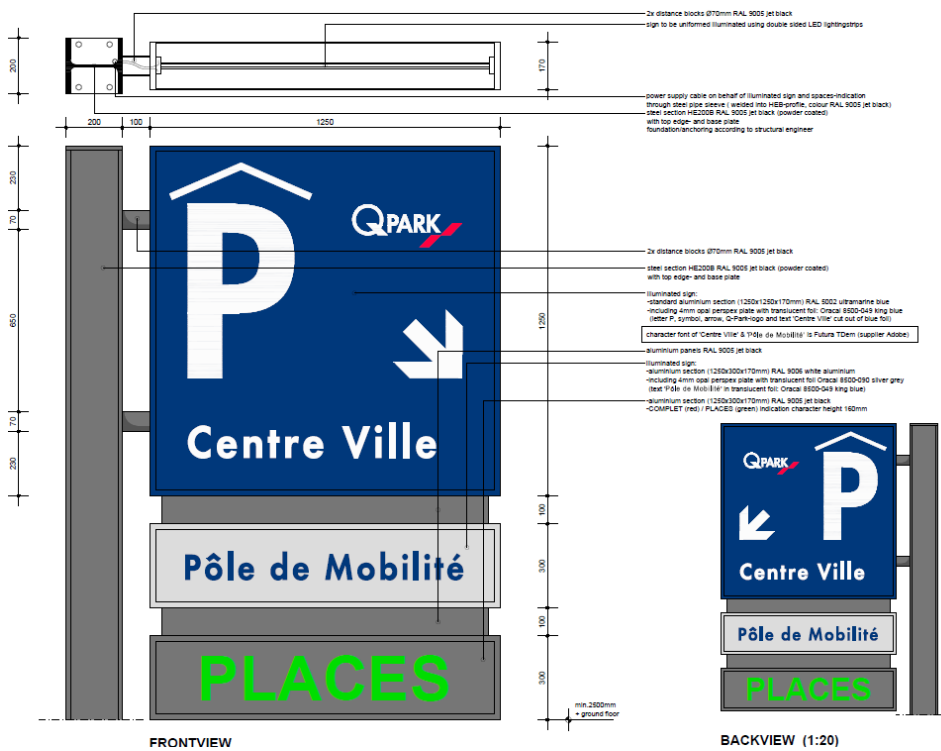

QP01A.1 Illuminated sign on column - Mobility Hub (FR)

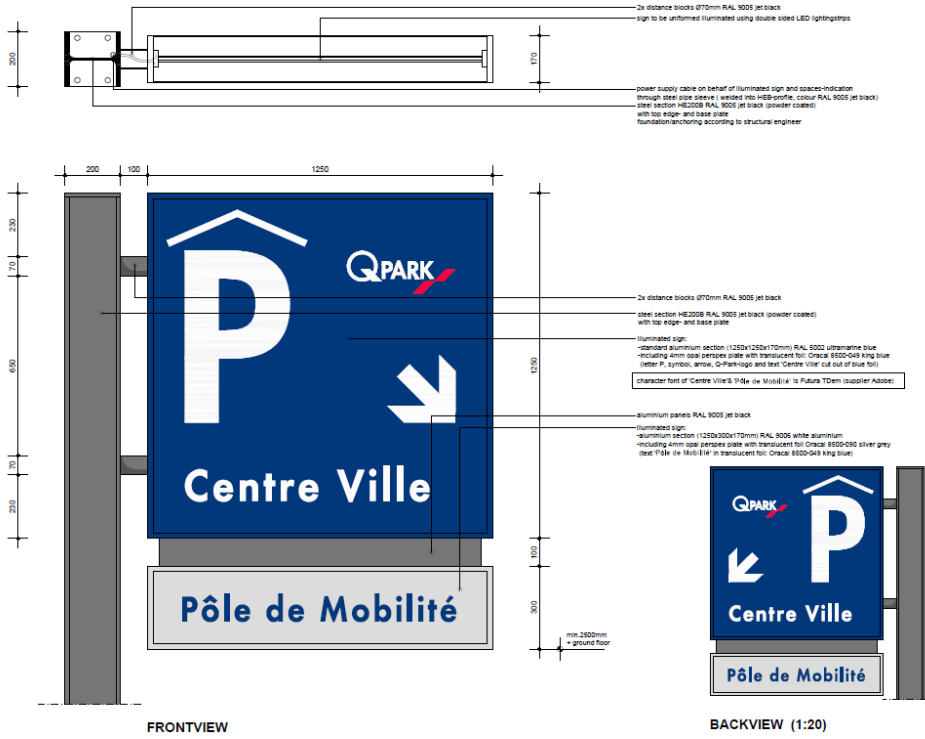

QP01A.2 Illuminated sign on column - Mobility Hub (FR)

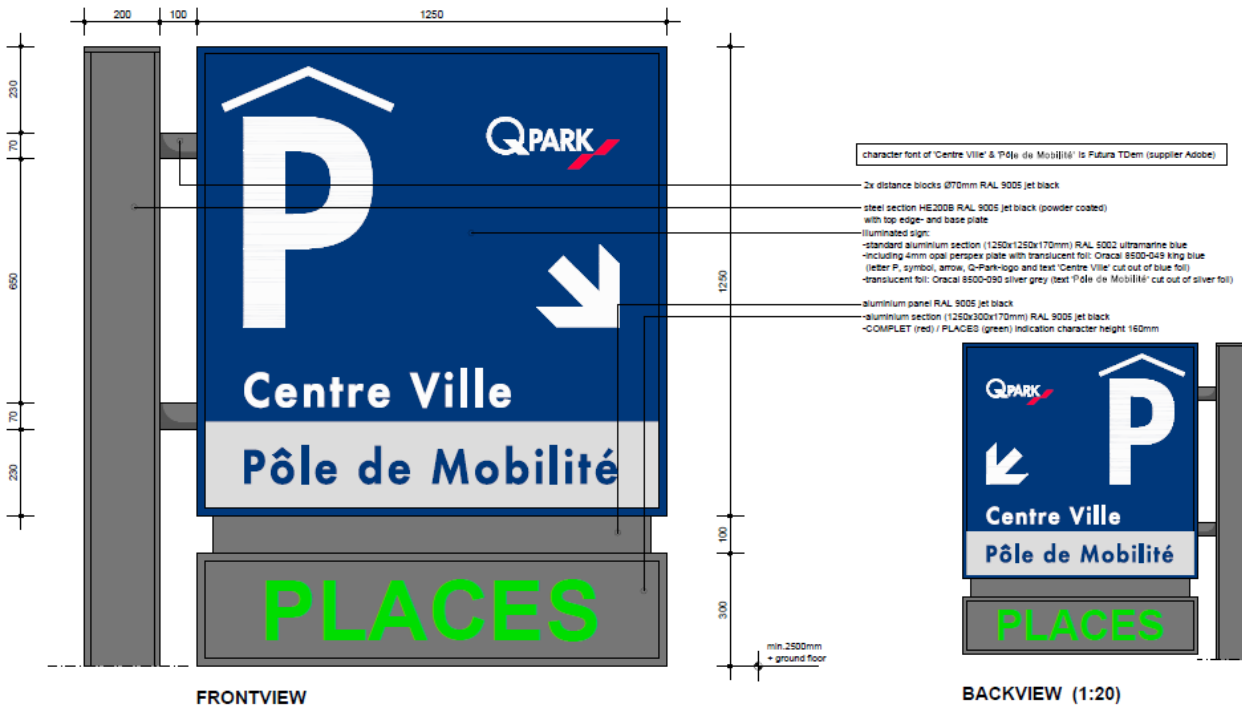
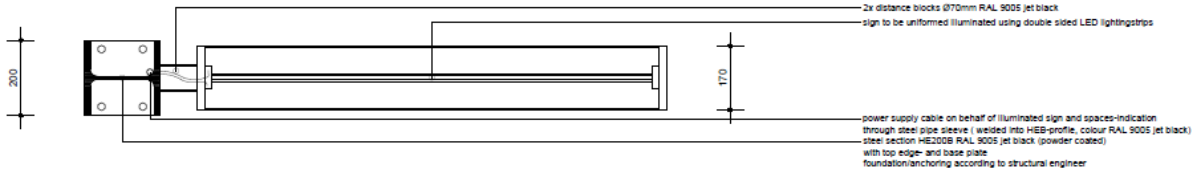

QP01B.1 Illuminated sign on column - Mobility Hub (FR)

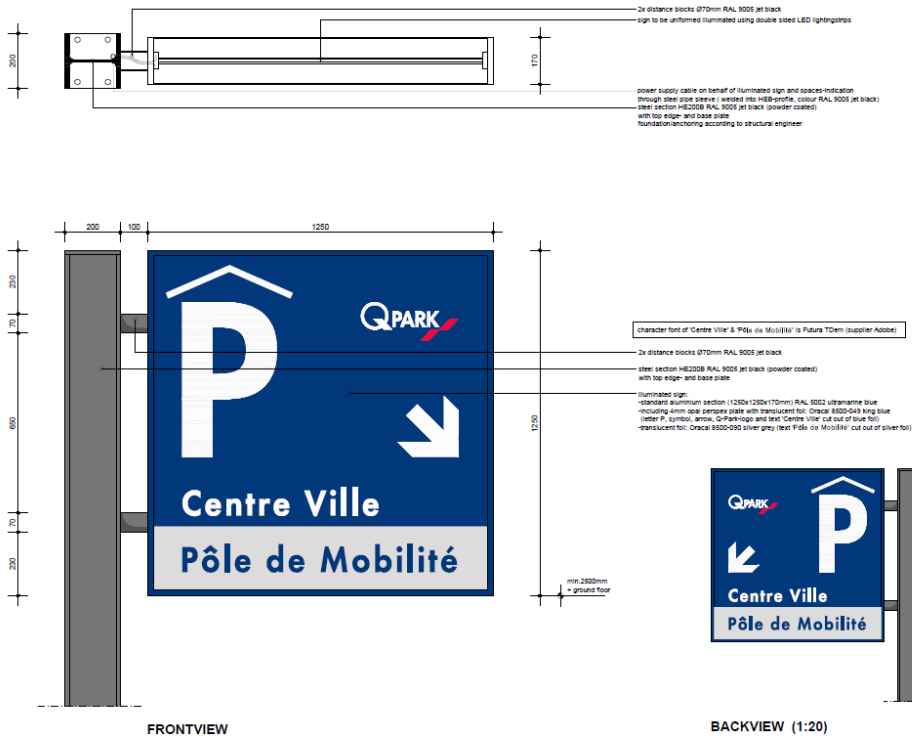

QR01B.2 Illuminated sign on column - Mobility Hub (FR)

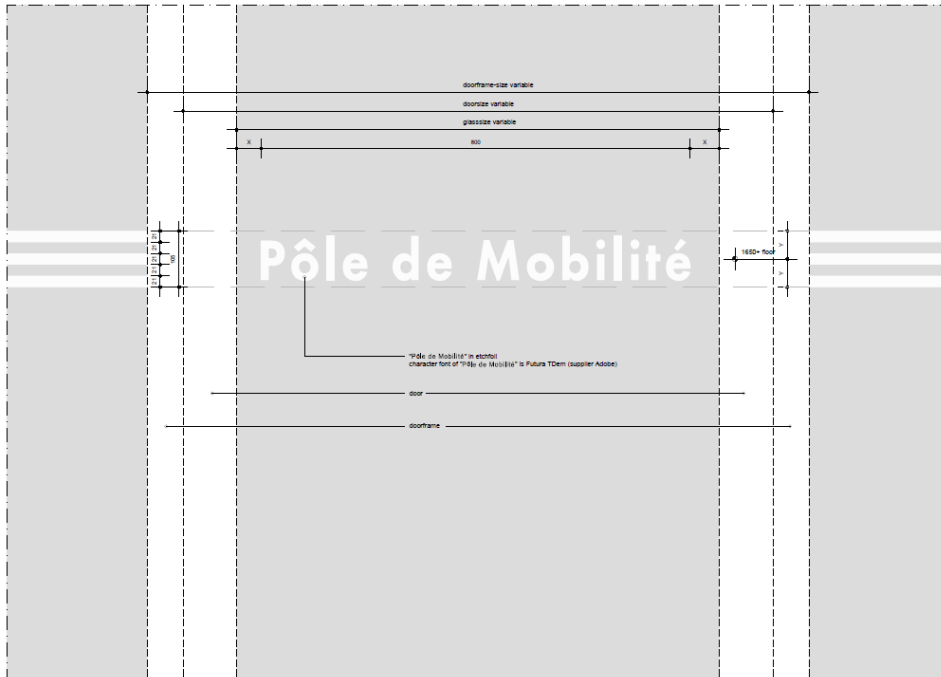

QR31 Principle etchfoil - Mobility Hub (FR)

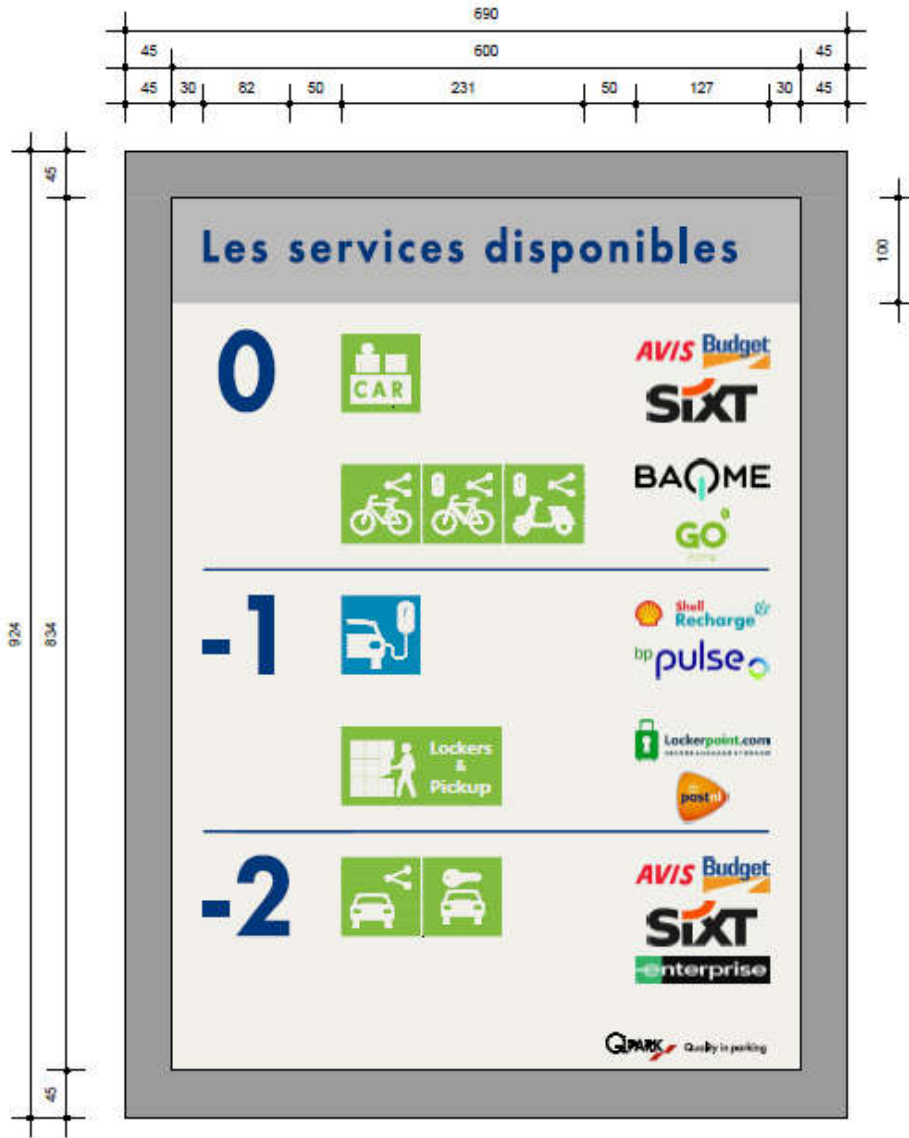

standard information sign  
Q-Park poster showcase A1-format (supplied by Q-Park)  
coated RAL 7034 signal grey  
at the backside: coverplate corresponding to the frame,  
(thickness according to supplier)

QP.33B Principle layout A1 frame - Mobility Hub (FR)

# A1 FRAMES

Note: for print material guidelines, please click [here](#).



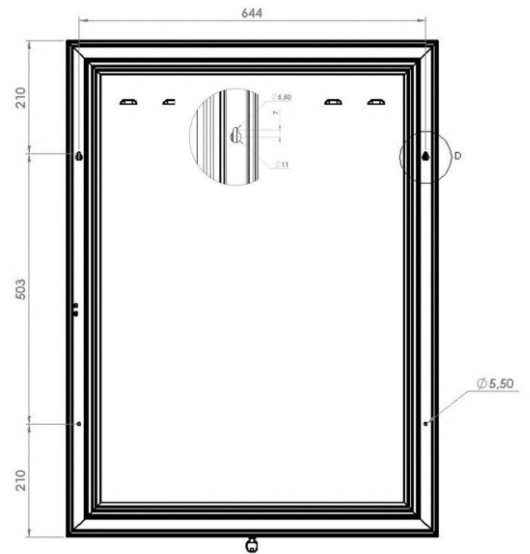
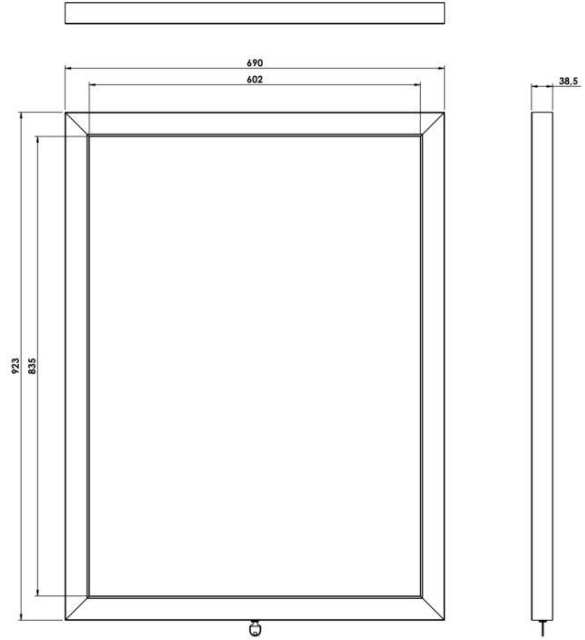



# STATIONARY

## DIGITAL STATIONARY

Always use the Q-Park templates when creating documents in Word, Excel and PowerPoint. These contain all the Brand Identity elements described elsewhere in the Q-Park Brand Identity.

### Content Management Systems

The Q-Park websites are populated and maintained using proprietary Content Management Systems (CMSs). The Q-Park house style has been programmed into the websites through the CSM style sheets (CSSs).

- | Sitecore for country websites.
- | Tangelo for corporate websites; financial and non-financial.

Visuals used on the Q-Park websites must conform to the guidelines for photos, visuals and icons.

### Microsoft Office

All Q-Park digital stationary is available to you by means of MS Office templates. When you create a new document, select one of the templates from the templates library.

- | To create your document in Q-Park house style, simply use the styles, heading and paragraph definitions available to you.
- | When inserting visuals, follow the guidelines for photos, visuals and icons.

### Word

Always start a new document using one of the Q-Park Word templates. Your document will automatically have the Q-Park colours available for headings and tables.

NEW; the word templates have a 'Rotate Page' option, allowing you to use portrait and landscape pages in a document.

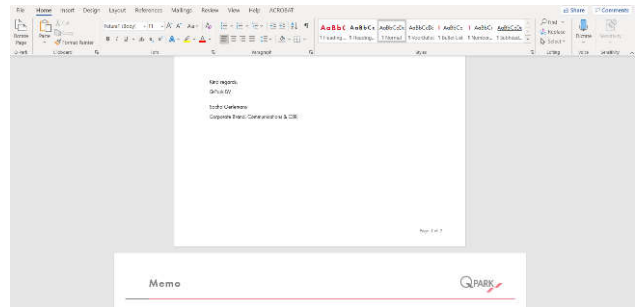

Rotate Page option - top left in the ribbon

### Excel

Always start a new workbook using the Q-Park Excel template. Your spreadsheet will automatically have the Q-Park colours available for graphs and charts.

Bar charts are the preferred form for representing data series. Black and grey scale are preferred for series. Only use shades of red if absolutely necessary.

## PowerPoint

Always start a new presentation using the Q-Park PowerPoint template. Your presentation will automatically have the Q-Park colours available for charts and diagrams.

If you need help to create a memorable presentation, please feel free to contact [sacha.oerlemans@q-park.com](mailto:sacha.oerlemans@q-park.com).

## E-mail

E-mails signatures are an important part of connecting with and information each other. E-mails sent to recipients outside Q-Park should always have a signature in the following format:

Met vriendelijke groet, / With regards, / Meilleures salutations, (use relevant language(s))

Your name

Q-Park Entity

Your position

**T** telephone number

**M** mobile telephone number (if applicable)

**E** e-mail address

**I** URL country website

Company name | Company address | Company postal code and city

Format telephone numbers with the international dialling code and group the digits so it is easy to read.

For example; +31 627 830 359

Do not use brackets as they limit smartphones to call the number directly!

## An example;

Met vriendelijke groet, / With regards, /  
Meilleures salutations,

Sacha Oerlemans

Q-Park BV

Corporate Brand, Communications & CSR

**T** +31 433 297 127

**M** +31 627 830 359

**E** [sacha.oerlemans@q-park.com](mailto:sacha.oerlemans@q-park.com)

**I** [www.q-park.com](http://www.q-park.com)

Q-Park BV | Stationsplein 8-E | NL-6221 BT Maastricht

In some countries you are legally obliged to include the number of the Chamber of Commerce number in business e-mail correspondence. In this case, add **C** and coc number.

Do not add any environmental, legal, social or commercial statements (nor logos etc) to your e-mail signature.

# PRINTED STATIONARY

## Logo positioning

The page margins are defined in terms of Q. Q is defined as the size of the capital Q in the Q-Park logo. Whatever the size or orientation of the paper, portrait or landscape, the margins are as follows:

- I Left margin:  $3xQ$
- I Right and top margin:  $2xQ$
- I Bottom margin:  $4xQ$ 
  - I The horizontal red line is placed at  $3xQ$  from the bottom of the page;
  - I This space is reserved for certificate logos and references, if relevant.

The remaining width between the left and right margins is divided into 3 equal parts known as y. Y defines the width and therefore height of the Q-Park logo with pay-off.



The Q-Park logo, with or without pay-off or add-on, is always placed flush to the right-hand margin.

## Letterhead

Q-Park letterhead paper may be pre-printed or created digitally in MS Word.

When working in MS Word, select the letter template from the template library.

Figure 65: Pre-printed stationary grid (A4 portrait)

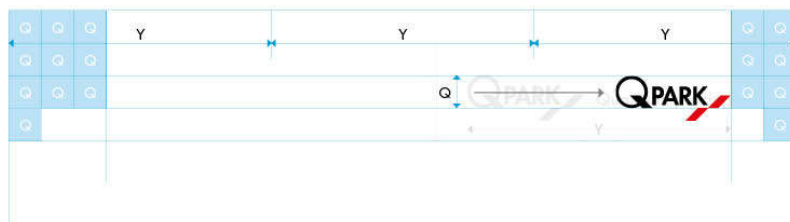
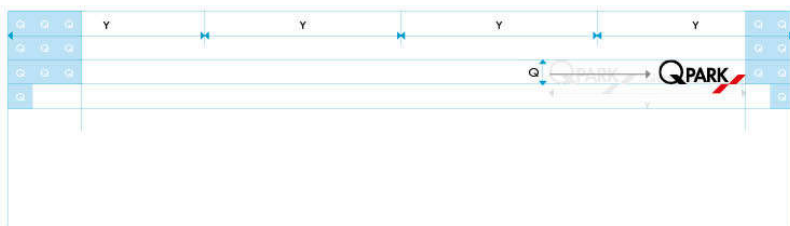

Figure 66: Pre-printed stationary grid (A4 landscape)



### Letterhead layout principles

The master logo in black and red is placed in the upper right-hand corner. The company’s legal name and address, postal code and town, telephone number, fax number, internet, e-mail address, bank and account number and VAT number are placed below the logo. This information is aligned to the left of the logo.

In the lower right-hand corner, under the horizontal red line, logos indicating ISO certificates or EPA and/or ESPA awards may be positioned. A paper code may be printed in the lower left-hand corner.

### Paper quality (when pre-printed)

Distinction Elegance, 90 gr/m2, with watermark  
Size A4 (210 x 297 mm)

### Typefaces used

Company name: Futura T Demi 9/auto  
Address & company info: Futura T 9/auto  
Plain text: Futura T 11 pt, line spacing 1.5

### Red line

A red line is used to separate the body text from the logos and any other information in the footer of the page. This line is Q-Park red, spans the page between the margins, and is 0.7 pt thick.

Download Adobe Indesign letterhead and continuation sheet templates for printing

If Futura T is not available on the computer, Arial may be used for plain text. If Arial is used for plain text typeface 10 pt should be used.

Figure 67: A4 letterhead grid

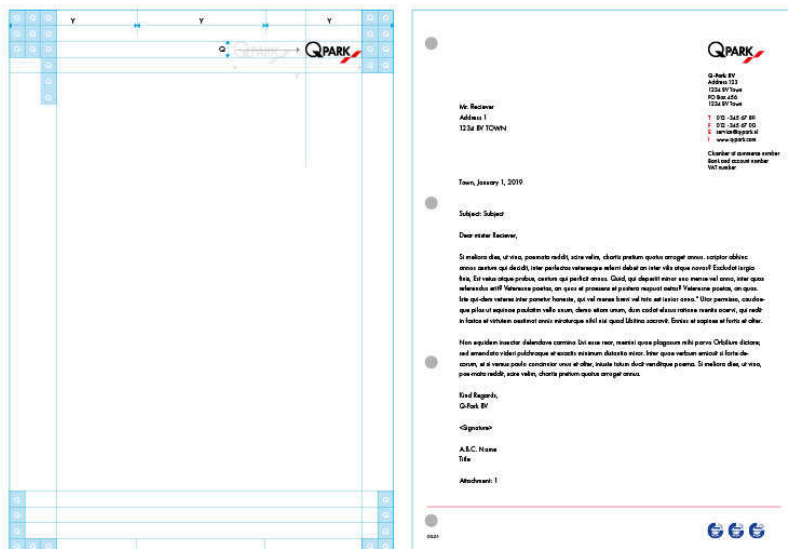

Figure 68: A4 continuation sheet grid

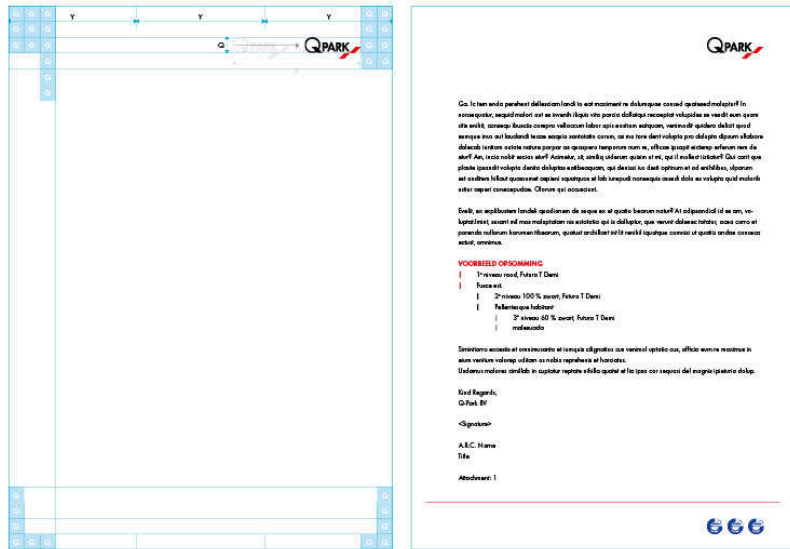
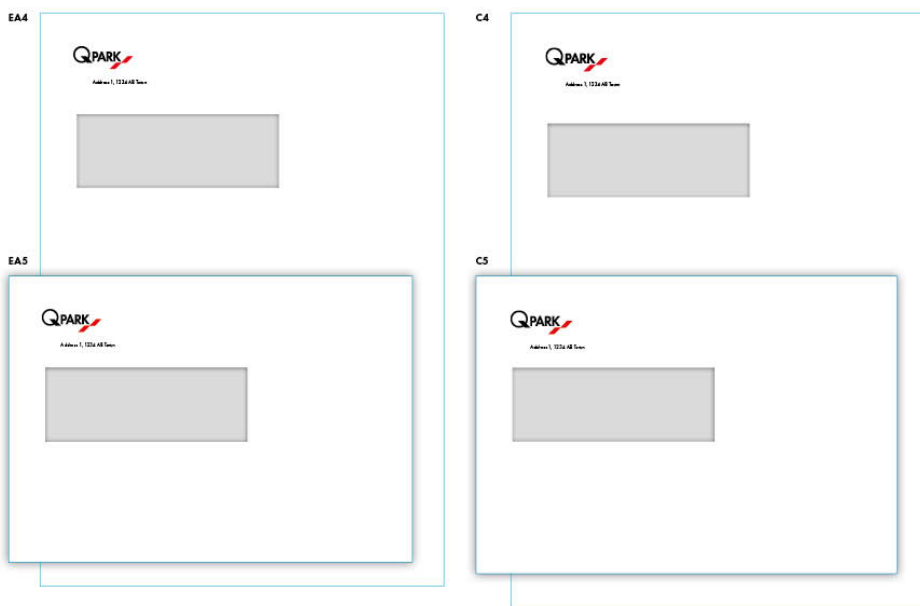

Figure 69: Envelope examples



### Continuation sheet

Only the master logo in black and red is placed in the upper right-hand corner. Paper, logo, typeface and line space are identical to the letterhead.

## Envelopes

The EA5 envelope is the basis for the format and positioning of logo and address. Q-Park prefers window envelopes as this means the envelope does not have to be addressed separately and so prevents errors being made with mailings.

### Positioning of the Q-Park logo

The master logo in black and red is placed in the upper left-hand corner and left-aligned with the window. The Q-Park office address, postal code and town are printed immediately below the logo on one line as it may not interfere with the addressee.

### [Left lined with the Q of the Q-Park logo]

In the downloadable templates you can switch off the window layer for plain envelopes without windows.

## Address

For the address use Futura T 9/auto

Download Adobe InDesign EA5 envelope template

Download Adobe InDesign EA4 envelope template

Download Adobe InDesign C5 envelope template

Download Adobe InDesign C4 envelope template

## With compliments card

Download Adobe InDesign With compliments card template for printing

## Paper

Distinction Elegance, 250 gr/m<sup>2</sup>

Size A5 (148.5 x 210 mm)

Figure 70: With compliments card grid

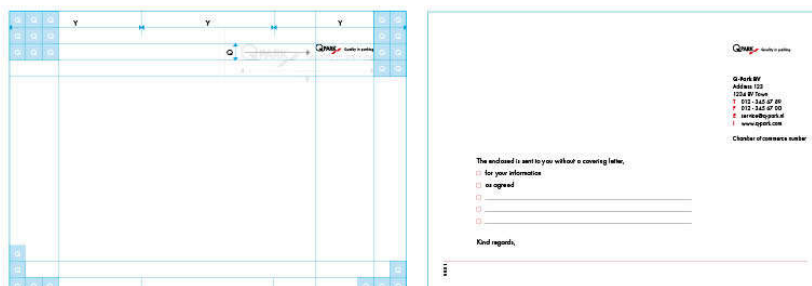

## Business cards

The business cards are printed on both sides in the two Q-Park primary colours (black and red). On the front, the Q-Park logo is placed in the upper left-hand corner.

Download Adobe InDesign Business Card template

The business card should contain the following information:

- | name
- | job title
- | PO box address (post address)
- | address (visiting address)
- | country
- | office telephone number
- | mobile phone, if applicable
- | e-mail address, if applicable
- | URL of the country website

## vCard QR Code

This information may also be added on the reverse of the business card as a QR code, which contains **the business card details as a vCard**. The QR code offers convenience as a smartphone adds the details automatically as a contact.

Figure 71: Business card grid



## Paper

For offset printing use Distinction Elegance, 250 gr/m<sup>2</sup>

For digital printing use Symbol Freelifa satin, 300 gr/m<sup>2</sup>

# COMMUNICATIONS

---

## GUIDELINES

### Digital guidelines

#### Online advertising

#### Bannering

#### Website

#### Job advertisements

A case study to recruit KE@Work students for two Business Intelligence projects.

Figure 73: Basic poster grid

---

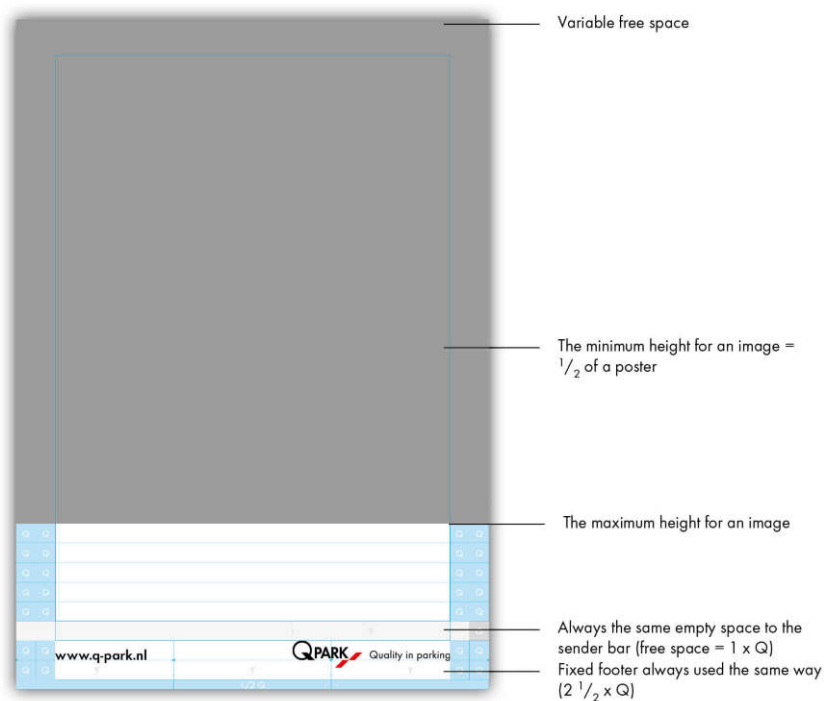



Figure 72: Job advertisement - Recruitment case study 1



## KE @ Work - 2 Project Proposals

### 1. Customer segmentation

- We want to define distinct customer types per car park
- We want to cross-check comparability of customer types
- We want to predict the optimal parking needs for season tickets customers, allowing us to free up parking spaces for ad hoc customers (i.e. increasing revenues per car park)

How do we enable you to tackle this challenge? You analyse key behavioural drivers, obtained from a combination of our parking data and data we've bought or collected from open data sources. You may want to start with analysing time and money spend, number of visitors at certain hours and days, discounts and campaigns, locations and POIs captured from Google APIs and the telecom industry, payment behaviours from banks and traffic data.

### 2. Portfolio benchmark

- We want to create a car park benchmark for acquisition purposes, comparing new with existing car parks
- We want to generate a database with key revenue drivers for car parks
- We want to have an in-depth understanding of the performance of competitive car parks

How do we enable you to tackle this challenge? You analyse our car park portfolio from a financial and location perspective, and combine our portfolio data with relevant desk research, data we've bought (or need to buy) or collected from open data sources. You may want to start with analysing our portfolio performance, competitive portfolio performance, influencing factors, dependencies, opportunities and relevant trends.

the content. The grid provides a frame on which the designer can place the graphic elements (images, letters, paragraphs) in an easy to process and well-thought-out manner.

For poster design we have developed a grid in which messages can be placed at various levels. We have developed several basic grids for communicating various different types of messages.

Here we make a distinction in brand, USP, campaign, information and pricing,

### Basic poster grid - three levels

We have defined three levels for posters:

- | main message only
- | main message with subheading
- | main message with subheading and body copy for extra information

The size of the main visual is at least half of the poster height.

I.e. the three levels of information are never more than half of the poster height.

## Tangible guidelines

### Commercial posters

In graphic design a grid is a structure that consists of a series of guide lines which are used to structure

Figure 74: Basic poster grid - three levels

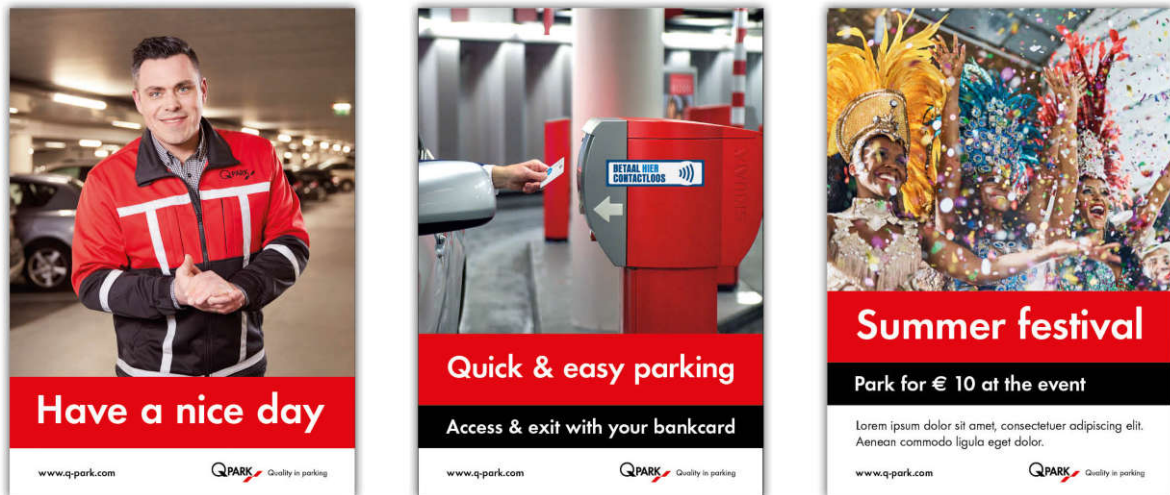

Download Adobe InDesign template Poster - red title bar

Download Adobe InDesign template Poster - red title bar - black subtitle

Download Adobe InDesign template Poster - red title bar - black subtitle - body copy

### Basic poster grid with call-to-action

Next to the basic poster grid including three levels, we've developed grids to include co-branding and call-to-action (CTA).

Figure 75: Basic poster grid - CTA



Download template Adobe InDesign template CTA

### Basic poster grid with co-branding

In some circumstances the Q-Park logo may be required in combination with the name or logo belonging to a commercial partner. Click [here](#) for co-branding guidelines.

Figure 76: Basic postere grid - co-branding



Figure 77: Poster example - Brand message



Figure 78: Poster example - USP message



Figure 79: Poster example - Campaign message



Figure 80: Poster example - Informative message

Version 1 - Body copy with attention



Version 2 - Co-branded



Version 3 - CTA



Figure 81: Poster example - Prices & Services

BIB - Blockpricing



Menu - Blockpricing



Brochures and flyers

Please submit your country specific examples / best practices.

Event material

Please submit your country specific examples / best practices.

**POS material**

Please submit your country specific examples / best practices.

**Production details**

Commercial campaign poster (short term); Maco Silk 200g

Commercial informative poster (long term); Polypropylene 350 micron/ $\mu\text{m}$  white, UV and moisture resistant

PMS display;

- | Dibond® (alternative names are Alupanel or Alubond), composite plastic core with aluminum top layer, 2 sides white RAL 9003, thickness 3mm, UV resistant
- | Fixation by Gripper / Cardholder

Figure 82: PMS display gripper / cardholder

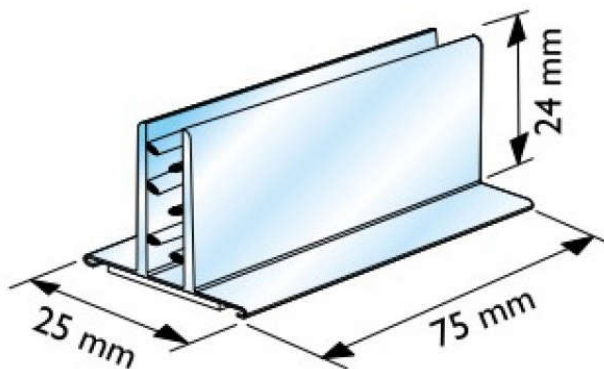

Bouwhek / et cetera

**Advertising**

Please submit your country specific examples / best practices.

**Parking facilities as advertising podium**

Q-Park, commercial partners and third parties may use the Q-Park parking facilities as a podium for commercial messages. This can be in many formats, for example: billboards, triangle boards, posters, product sampling, parking marked cars.

**The rules are:**

- | Our brand identity and quality standard are our top priority. Additional revenue is of secondary importance.
- | Q-Park has a quality standard for advertising frames.
- | We do not want media carrier overkill, we look for the best places without hindering customers.
- | Media carriers may only be placed in pedestrian zones.
- | No advertisements are permitted at the parking facility entrances or exits.
- | We do not advertise on the access and exit barriers.
- | We do not permit posters or other expressions without frames.
- | The marketing manager of each Q-Park country bears final responsibility for the advertising project. They negotiate the contract together with the country managing director.
- | The real estate manager bears final responsibility for placing and maintaining the advertising frameworks.
- | We work with preferred suppliers and media partners on a European-wide basis.

**Other locations, special formats and concepts**

Special locations such as off-airport parking, train stations (P+R), and motorway locations must be negotiated with Q-Park representatives. These projects are complex in nature due to other contractual commitments and political or environmental regulations. Q-Park will suggest possible locations for special formats and/or spectacular concepts. These specials require negotiation and different contracts. All Brand Identity rules apply to these special

formats and need to be approved by the Corporate Brand Custodian.

### Special deals, bartering and joint promotions

The Q-Park marketing manager can make special barter deals and joint promotions. These can be negotiated in the contract between Q-Park (country) and the requester. They can be used to promote Q-Park or third-party services and/or products.

### Maintenance

Q-Park strives for the highest quality. Well-designed advertising units must be maintained and kept in top condition.

### The maintenance programme should include:

- | routine maintenance activities;
- | rapid response service;
- | safety and preventive maintenance activities;
- | inspection and quality control;
- | customer service and complaint handling.

### High quality products:

- | Static as well as dynamic units must be constructed with the best-tested and most reliable parts.
- | Units should be mounted into specially designed casings, in order to withstand the environmental conditions specific to parking facilities.
- | Casings should be made of aluminium and be powder coated in the desired Q-Park colour.
- | Toughened or layered safety glass must be used together with a high-quality, vandal-proof closing mechanism.
- | To prevent breakdown and defects, technical parts must be replaced before the end of the useful life span is reached.

### WDQ campaign

WDQ stands for We Develop Quality. The WDQ expressions use the WDQ logo, and images have a red boarder at the bottom.

The aim of the WDQ campaign is to create and maintain awareness of Q-Park's PODs and POPs among public and private landlords, project developers and Q-Park employees.





You can find WDQ visuals for PowerPoint presentations and Social Media on Idefix.

 [Find WDQ Campaign Expertise Articles here.](#)

### Value creation

We use brand and marketing as a tool in the overarching strategy to create value for our stakeholders:

- I Meaningful brand
- I Focused marketing

We want to build further on the Q-Park brand to support the acquisition and sales process:

- I Acquisition process is aimed at public and private landlords: to add contracts to the portfolio.
- I Sales process is aimed at commercial partners: to broaden our sales channels.

---

# CONVENTIONS FOR VISUALS AND THE LOGO

For details about using the Q-Park logo, please refer to the Brand identity LOGO section and the Brand identity Don'ts.

## Use Q-Park colours

The correct Q-Park colours for use in documents are incorporated in the Q-Park templates available for Word, Excel and PowerPoint.

Q-Park colours are defined in the Visual Identity colour section.

For information about the colours you can use in charts, graphs and tables see the primary colours section.

## Q-Park icons

- I Use Q-Park icons for our services, wayfinding and the like. These are available in Idefix.
- I There are special icons for the various Q-Park programmes, see programme logos.
  - I PaSS (Parking as Smart Service)
  - I Sustainable Mobility Partner (SMP) Programme
  - I EV charging
  - I Mobility hubs
- I If there is no Q-Park icon for your purpose, you may use icons freely available online to embellish and/or clarify your text:
  - I use really smart/clarifying icons, something that makes sense to a 'new' reader;
  - I never use USA styles, dollar signs and the like;
  - I avoid using round elements, rounded corners, and circles;
  - I to request a new Q-Park icon be created in Q-Park colours contact Corporate Brand & Communications

## Visuals included in writing

Visuals of all types can be used to clarify information or a concept that is complicated to explain in words. Use photos, infographics, tables, charts and graphs where applicable.

To have an infographic redrawn in house style, please contact Corporate Brand & Communications

Take note of the following dos and don'ts when including visuals in your text.

### Do

Leave white space around a visual element. We call this the 'safe zone'.

Use icons and visual elements with right-angled corners. This emphasises our brand image.

Always add a caption or title.

- I If appropriate for your text include numbering. This makes it easy to refer to the visual in the text.

Always state the source and credit the copyright holder.

---

### Don't

Place text over a visual element as this detracts from the readability

Use icons or visual elements with rounded edges, shadows etc. This would detract from our brand image

---

# tone of voice and writing guidelines



At Q-Park, we write in a business-friendly **tone of voice**. We talk to the reader. This means the message should meet the recipients' needs, whether they are a customer, a partner or a prospect.

In this style guide we explain our preferred writing style and **tone of voice**, and how we work with visual elements, including space, to convey our message to customers, prospects, business partners and colleagues.

Q-Park is about space – space for parking. So, we also use a lot of space in our communications. Space in your communications reflects the space we offer in our parking facilities.

## Writing about Q-Park

- When referring to the company, the company is singular so write: 'Q-Park is...'

- When writing on behalf of the company, write: 'We are...'
- Never write 'Q-Park are...'

In your text, ensure that our name is NEVER split across two lines. Our content management system (CMS) Tangelo is programmed to prevent this from happening. In other documents, use a 'non-breaking hyphen'.

When referring to the Q-Park countries, always present in this sequence. The appropriate currency and currency code are included here for your convenience:

Country	Abbreviation	Currency	Currency code
Netherlands	NL	euro	EUR
Germany	DE	euro	EUR
France	FR	euro	EUR
Belgium	BE	euro	EUR
United Kingdom	UK	pound, pound sterling	GBP

Country	Abbreviation	Currency	Currency code
Ireland	IE	euro	EUR
Denmark	DK	kroner	DKK

## Writing for Q-Park

### Basic guidelines

All Q-Park communications should be clear and concise, and easy to understand at a glance – for visuals, and on first reading for texts. Follow your country/language 'plain language' guidelines.

- | Use **inclusive language** so not to offend
- | Use the **active voice** to communicate in a direct, concise and dynamic tone
- | Be **positive** and emphasise what can be done
- | **Give credit** for sources and images used and respect copyright.

### Writing for the digital world

Text for web pages should be brief and to the point:

- | Each page deals with a **single topic** or one **specific key word**
- | Use approximately 200-250 words per section/heading/screen, yet ensure the **information** you provide is **complete**
- | Use **short sentences** but do not oversimplify.

Website visitors scan rather than read:

- | Structure the information using **headings** and **subheadings**
- | Always mention the **key word** of the page in the **first heading** of your text
- | Ensure that headings, paragraphs and colours are used consistently
- | Use bullets to convey information concisely
- | Use FuturaTDem to emphasise (never bold).  
Note: The Content Management System (CMS) for adding content to the corporate and country websites does this automatically, as do the Q-Park MS Office templates.

Make the text inviting and attractive:

- | Use the **key word** of the page in the **title**

- | Keep titles brief
- | Avoid superlatives in titles.
- | When placing links in text, inform visitors what they will find
- | Split **sentences** so each contains only **one idea**
- | Alternate short and longer sentences to recreate the rhythm of natural speech
- | Use WE when speaking about Q-Park and YOU when referring to the customer or partner
- | Use everyday language that resonates with the target audience
- | Avoid using jargon. If you must, use a specific term and make sure you give an explanation.

### Reports

When writing **reports** and **printed (PDF) documents** take these guidelines into consideration:

- | Don't leave just one word on a line, no widows/orphans.
- | Figures and charts:
  - | align to the left or right margin
  - | add a caption
  - | number figures and charts for easy reference
  - | credit the copyright owner, if applicable.
- | Tables:
  - | Align to the left margin
  - | add title above the table
  - | number tables for easy reference.
- | In long documents, such as annual reports:
  - | Use headings to help the reader navigate through the document
  - | number the figures, charts and tables for easy reference
  - | credit the copyright owner, if applicable
  - | create a table of contents using the top heading levels
  - | create a list of figures, charts and table as part of the table of contents.

## Social media

When writing for **social media**:

**I** Use **CamelCase** for **hashtags** because:

**I** your audience can see meaning at a glance;

**I** screen readers can pronounce the words.

### Do

#QParkNews

#PrideWeekHamburg

#CityCentre

#MeetTheTeam

### Don't

#qparknews

#prideweekhamburg

#Citycentre #CITYCENTRE #citycentre

#meettheteam #MEETTHETEAM #Meettheteam

## Writing recommendations

All Q-Park communications should be clear and concise, and easy to understand at a glance – for visuals, and on first reading for texts. Follow your country/language 'plain language' guidelines.

**I** Use **inclusive language** so not to offend

**I** Use the **active voice** to communicate in a direct, concise and dynamic tone

**I** Be **positive** and emphasise what can be done

**I** **Give credit** for sources and images used and respect copyright

### Use meaningful headings

Keep headings to a single line. Write a meaningful phrase that informs the reader about what's coming next. The ideal heading length will depend on where the text will be published. Remember that website texts must also be easy to read on smaller devices such as tablets and smartphones.

### Good style

Use meaningful headings:

How to read this report

Summary of our findings

### Try to avoid

Heading using just one or two words:

Introduction

Conclusion

### Write in the active voice

Wherever possible, write in the present tense. This creates an active narrative which is attractive to read. This usually generates a more compact text.

### Good style

Q-Park Windsor Yards renovation is now complete.

### Try to avoid

The renovation of the Q-Park Windsor Yard car park has now been completed.

### Vary the sentence length

Another aspect that makes writing attractive to read is varying sentence length. Sentences with 15 to 20 words are generally easy to read and understand. Try to avoid

sentences with 30 or more words, split such sentences or create a bullet list. Short sentences convey information quickly and reliably.

### Write compact sentences

	Good style	Try to avoid
... of the ...	the car park's entrance	entrance of the car park
the ... of	renovating	the renovation of

### Using abbreviations

- I When using these terms and abbreviations always add an explanation and put the abbreviation in brackets, then you can use the abbreviation in your text.
- I When writing for a website or report, repeat the full term at the start of an article, section or chapter, as the reader may be jumping in without having read the previous explanation.

You will find a list of abbreviations including their meaning and use within Q-Park in the Q-Park terminology section.

### Gender sensitivity

We use gender-neutral and gender-inclusive language. So, when referring to individuals use the 'singular they' (they/them/their) or similar device in your language, such as a general plural.

We use gender neutral form for professions and professionals

#### Do

Parking Host

Parking Attendant

QCR operator

Colleague, coworker (different section)

salesperson, sales executive

chair, chairperson

athlete

firefighter

#### Don't

parking hostess

parking attendant

employee

salesman, saleswoman

chairman, chairwoman

sportsman, sportswoman

fireman, firewoman

**Job titles**

We always use a gender-neutral term for job titles and positions.

If a job title has multiple words, then all parts start with an uppercase letter, for example

| Parking Host

| Parking Attendant

**Proper names**

Take care to write people's name correctly. In Dutch, family names with 'de' or 'van' in the middle take a lowercase letter; in Belgium, this is usually an uppercase letter.

**Do**

Frank **De** Moor

Philip **De** Brabanter

**Don't**

not Frank **de** Moor

not Philip **de** Brabanter

**Currency conventions**

Each language has its own conventions when writing money amounts which you should follow when writing in your local language. Also follow these general guidelines:

| In reports (B2B) use ISO three letter currency code

| For websites and e-mails and other communications with customers (B2C) use the currency symbol

| When writing negative money amounts use a minus sign

Country	Abbreviation	Currency	Currency code	Currency symbol
Netherlands	NL	euro	EUR	€
Germany	DE	euro	EUR	€
France	FR	euro	EUR	€
Belgium	BE	euro	EUR	€
United Kingdom	UK	pound sterling	GBP	£
Ireland	IE	euro	EUR	€
Denmark	DK	kroner	DKK	kr.

**Currency dos and don'ts**

	Do	Don't
<b>B2B examples</b>	EUR 129.3 million	€129.3 million
	EUR -18.6 million	€-18.6 million €(18.6) million
	EUR 18.6 million	€18,600,000.00
<b>B2C examples</b>	€ 25.5 per day	EUR 25.5 per day
	€ 0.75 per hour	EUR 0.75 per hour

## Phone number styles

Always include the country code, omit the leading zero, and leave a space between blocks of 3 or 4 digits for easy reading. This is also known as international style.

	Do	Don't
Phone numbers	+31 6 1234 5678 +44 20 1234 1234	+31612345678 +4402012341234 +31(0)612341234

## Quality check

Use this checklist before publishing or sending out anything you have written. After all, we're only human and humans make typos, and we have tools to help us.

- | Is the spelling and grammar correct. Use the spelling checker but don't rely on it blindly.
- | Is the text well-structured and logical
- | Is everything covered
- | Is the content accurate

- | Is the level of detail appropriate
- | Is there irrelevant information that can be omitted
- | Is the communication:
  - | specific
  - | concise
  - | consistent
  - | unbiased
- | Do use the spelling checker. Be aware that it may suggest splitting or joining words when they should be written together or separately:

### Do

cybersecurity

healthcare

multistorey

ongoing

rooftop

wellbeing

### Don't

cyber security

health care

multi-storey

on-going

roof top

well-being

- | If time allows, use the **read aloud function** to listen to what you have written.
  - | you simply left out the last letter:  
**made, mad**
  - | you may accidentally type **form** when you mean **from**

- | you may use the incorrect spelling with a totally different meaning. Here are some examples of these **confusable words**:

**advice** (noun, suggestions or encouragement)

**advise** (verb, to suggest or encourage)



---

<b>board</b> (group of decision makers; a thin or flat piece of wood)	<b>bored</b> (uninterested or lacking challenge)
<b>complement</b> (match or complete)	<b>compliment</b> (praise or flattering remark)
<b>counsellor</b> (therapist or advisor)	<b>councillor</b> (local government officer)
<b>licence</b> (noun, a document that allows you to do something)	<b>license</b> (verb, the act of allowing someone to do something) Example: license to operate
<b>weather</b> (rain, sunshine etc.)	<b>whether</b> (a query or option)
<b>you're</b> (you are)	<b>your</b> (belonging to you)
<b>roll out</b> (Q-Park rolled out its EV charging programme)	<b>roll-out</b> (roll-out of digital services)
<b>their</b> (belonging to)	<b>there</b> (there are; over there) <b>they're</b> (they are)

# CORPORATE ENGLISH STYLE GUIDE

## We write EU English

The term EU English is used to refer to a particular variety of English. It involves both EU terminology and a number of other EU-specific lexical, grammatical and discourse features. As the EU is involved in all walks of social, political and cultural life, EU English features characteristics of political, legal, business, and even academic discourse. This reflects the different functions and multiple activities of the European Union as a cultural, political and historical reality.

## Which spelling variant

At Q-Park, when writing in English, we use **UK spelling** with **S** (-ise) not **Z** (American). If in doubt, consult the online Collins English dictionary (free access).

For your reference, here are some **preferred spelling** examples of commonly used words to write with S and not Z:

Do	Don't
digitalisation	digitalization
organisation	organization
maximise	maximise
monetised	monetized
optimised	optimized
optimising	optimizing
realised	realized
recognised	recognized
utilisation	utilization

Here are some other common UK-US spelling variants to note:

Do (UK spelling)	Don't (US spelling)
colour	color
neighbourhood	neighborhood
travelled	traveled

## One or two Ss, Ts?

Words where the letter may be doubled before the ending – both forms are correct, but at Q-Park we use the variant with a single letter:

Do	Don't
focused/focusing	focussed, focussing
benefited/benefiting	benefitted/benefitting

bus, buses

busses

**Units of measure**

We always use metric units – metre, kilometre, Celsius or °C, kWh, MWh, GWh

- | When combining with a number leave a (non-breaking) space between the number and the unit, except for temperature and percentages

- | When writing a range do not repeat the unit, and use 'to' in running text

- | Always use a subscript 2 in the abbreviation for carbon dioxide

	<b>Do</b>	<b>Don't</b>
	5 m	5m
	25 km	25km
	25°C	25 °C
	96%	96 %
In text	5 to 10°C	5°C to 10°C
In tables	20 to 25 metres	20 metres to 25 metres
	20-25 m	20 m – 25 m
	CO <sub>2</sub>	CO2
	tCO <sub>2</sub>	tCO2

**Using numbers**

- | Write numbers one to ten as words, use numerals for numbers 11 and greater.
- | Avoid starting sentences with numbers; most can be spelled out, so try to write the sentence a different way.
- | Year as this must be written in numerals.
- | Money is always expressed in numerals.
- | For numbers above one thousand, except dates, use the correct separators: 12,456.98.

- | Negative numbers: prefix with a minus sign.

- | Percentages:

- | no space between the number and the % sign

- | use either digits and symbol or all words, do not mix

- | Units of measure: place a space between the number and the unit of measure abbreviation

**Do**

one in five

120 people attended the meeting

**Don't**

1 in 5

one hundred and twenty people attended the meeting

an increase of 5% an increase of five percent a decrease of 61%

EV charging points consumed 5.4 GWh

### Dates and times

To avoid any confusion always write the date in full in running text. Write the month in words and always put the month in the middle. This is the European way of writing dates.

an increase of 5 % an increase of five % an increase of 5 percent

a decrease of 61 percent

EV charging points consumed 5.4GWh

Do not use superscripts with the day number. If the day of the week is included, there's no comma after the day.

When referring to a decade, write the 1990s, no apostrophe, never write 'the nineties'.

	Do	Don't
<b>Date styles</b>	5 Jan 2024 5 January 2024 05-01-2024 05/01/2024 Monday 5 January 2024  1990s	Jan 1, 2024 1 <sup>st</sup> Jan 2024 January 1 <sup>st</sup> 2024 05/01/24 Monday, 5 January 2024 Monday, 5 January, 2024 Monday 5, January 2024 Monday 5 January, 2024 Monday 5 January '24  1990's the nineties
<b>Time styles</b>	09:30 14:00 12 noon 24:00	9.30 a.m. 2 p.m.

## Punctuation

You will find many punctuation rules in grammar books and on the internet. In this section we highlight a few punctuation elements and their specific use at Q-Park. These will help you avoid making some common mistakes.

### Apostrophes

In English we use an apostrophe for three reasons:

1. To show that one or more letters are missing

#### Examples

- ! I'm going to park in Q-Park Piccadilly Place
- ! You **can't** use cash here

2. To show possession

#### Examples

In the singular, the apostrophe comes before the 's'.

- ! The **customer's** journey (one customer)

In the plural it comes after the 's'.

PaSS simplifies our **customers'** journeys  
(several customers)

If a plural noun doesn't end in 's', add an apostrophe and an 's'

**Q-Park's** style guide  
The **facility's** entrance

For names or singular nouns that end in 's', 'x' or 'z', we usually add an apostrophe followed by 's'.

The **bus's** journey ends at the transport hub  
The ticket **box's** lid was left open  
The **quiz's** theme is parking

### 3. In some expressions of time

#### Examples

We give one **week's** notice for maintenance work  
Customers give four **weeks'** notice to cancel a season ticket

#### Don't

We give one **weeks** notice for maintenance work  
Customers give four **weeks's** notice to cancel a season ticket

### Apostrophe don'ts

Do not use an apostrophe when making something plural.

	Do	Don't
Dates and years	In the <b>1960s</b>	In the <b>1960's</b>
Abbreviations	We recently opened two new <b>PFs</b> in Rotterdam.	We recently opened two new <b>PF's</b> in Rotterdam.
	We identify <b>CSFs</b> and set targets for our <b>KPIs</b> .	We identify <b>CSF's</b> and set targets for our <b>KPI's</b> .

### Apostrophe confusion

Do you ever get confused with it's and its? There's an easy way to remember which to use. The confusion is

understandable. You'll find a more detailed explanation here in the Cambridge Dictionary.

	Do	Don't
Verb	<b>it is</b> sunny <b>it's</b> sunny	<b>its</b> sunny
	<b>it has</b> been raining been raining	<b>its's</b> <b>its</b> been raining
Possessive	take the card out of <b>its</b> holder	

Remember: his, hers, its

## Capitalising headings and terms

In our chosen style, in titles and for terms consisting of more than one words, we only capitalise the first word.

### Do

Key theme of the presentation

Public transport improves liveability

Shared mobility makes economic sense

### Don't

Key Theme of the Presentation

Public Transport Improves Liveability

Shared Mobility makes Economic Sense

When writing terms such as key theme, public transport, shared mobility and the like in full sentences, do not use uppercase/capital letters. If you need to emphasise such terms, consider using bullet points, and bold (FutureTDem) to draw attention. For example:

! **Key theme** of the presentation

! **Public transport** improves liveability  
! **Shared mobility** makes economic sense

If a heading has an explanation or additions phrase after a colon [:] the following word starts with a lowercase letter.

### Do

Reducing complexity for public services: hospital parking

### Don't

Reducing Complexity for Public Services: Hospital Parking  
Reducing complexity for public services:  
Hospital parking

## Brackets

Brackets can be used to add information to a sentence, which can be read (and understood) with or without the information between brackets.

In Dutch, you can use brackets to indicate alternatives and save space, but this is very confusing for people who do not know this usage.

### Do

Use and abuse

Bicycles

motorbikes

### Don't

(ab)use

(brom)fietsen

(motor)cycles

(motor)bikes

## Hyphens and dashes

The longer en dash (–) can function like a comma, a colon, or parenthesis. It is used to separate extra information – instead of brackets – such as examples, explanations or supplementary facts and always has a single space on each side ' – '.

### Remember:

- ! Hyphen (-)
- ! en dash is approximately the length of the letter N (–)
- ! em dash the length of the letter M (—)  
! we don't use the em dash in Q-Park Corporate English

When writing ranges, do not add a space around the en dash.

Note:

- | in Word and PowerPoint, a dash/minus sign/hyphen is turned into an en dash when you type a space after the next word.
- | in Windows on a keyboard with a numeric keypad use Alt + 0150 to create an en dash.

	Do	Don't
<b>Use an en dash</b>	as punctuation Liveability – shifting parking from on-street to off-street	Liveability - shifting parking from on-street to off-street
	meaning 'to'	Brussels - Maastricht
	Brussels–Maastricht	Brussels-Maastricht
<b>Use a hyphen to</b>	indicate a range	10:00 - 12:30 1998 - 2024
	10:00-12:30 1998-2024	10:00 – 12:30 1998 – 2024
	break words at the end of a line	

- | Do not use hyphens to abbreviate words:

Do	Don't
internal and external	in- and external
bilingual and multilingual	bi- and multilingual

### Hyphenation rules

The following list of words commonly used in Q-Park texts which are hyphenated, or not.

If in doubt, consult the online Collins dictionary (free access).

Term	Example or meaning	Don't
cash flow		
city centre		
long lease	long-leased parking facility (adjective)	
long-term	long-term lease (adjective)	
mega	megawatt, megatrend,	Words beginning with 'mega' do not have a hyphen
multi	multifunctional, multicultural, multistorey, multimodal	Words beginning with 'multi' generally do not have a hyphen - <b>except</b> if the second part begins with a vowel.
	multi-access, multi-use, multi-occupancy	
off-street	off-street parking – not on a public road	

on-street	on-street parking – at the side of a public road	
pre-book, pre-booking	customers can pre-book a parking space via the website.	At Q-Park, we don't use reserve or book.
pre-tax	before the deduction of taxes	
short-term	short-term parking	
top-up	top-up charge for electric vehicle	
wellbeing		Well-being is also correct, but at Q-Park we prefer wellbeing without a hyphen.

### Lists and bullet points

We recommend breaking down complicated information and presenting this in a bulleted list. There are different ways to punctuate lists, depending on the information you are presenting. Here are examples of the most common forms. For Q-Park communications, we recommend using types A & C.

#### Type A: A list in which each point is a complete sentence

The Managing Director made three comments about using information technology.

- | All barrier equipment and PMS need to be kept up to date.
- | Staff must be trained to use new equipment.
- | Don't think that AI and technology will solve all our problems – it won't.

#### Type B: A list which is a continuous sentence

We want to keep the party clean and tidy, please remember to:

- | wash mugs and glasses and put them back in the cupboard;
- | label your own food before putting it in the fridge; and
- | clean up after you have used the pantry.

#### Type C: A list of very short points

Every good parking facility should have the following:

- | ANPR
- | Clear signage
- | EV charging points
- | Spaces for PRMs.

Where possible, choose a system and be consistent in its usage throughout a document; however, in a publication with many diverse lists it may be better to allow all three types rather than to impose an artificial uniformity.

### Quotation marks and their proper use

- | Quotation marks are used in pairs, either single ( ' ' ) or double ( " " ).
- | Q-Park house style prefers the curly variants so quotation marks do not get confused with apostrophes ( ' ).
- | At Q-Park we use double quotation marks ( " " ) to indicate speech and citations and single quotation marks ( ' ' ) to indicate a special word or a word or phrase used in an unusual way.
- | When reporting speech, for example in a press release, remember to put the punctuation inside the quotation marks.
  - | John Denton, Head of Commercial at Q-Park added "Q-Park aims to be the Sustainable Mobility Partner of choice by 2030. Strategic partnerships such as the 'Dark Hub' at Leicester Square allow us to make a real difference for the working people of London."



---

# TOOLS

## Shutterstock

Shutterstock is a leading global provider of high-quality licensed images, videos, and music. Shutterstock helps inspire creative professionals by providing diverse content to businesses, marketing agencies and media organisations around the world.

Content creators contribute their work to Shutterstock, where end users buy and use it in a diverse array of creative personal and business projects. It's a two-sided marketplace that empowers the world's storytellers.

Q-Park has a team account for rights-free images only. You are invited to register and make use of this tremendous database of licensed images.

Note; our account has an active footage plan as well, **yet no** active music plan nor an editorial plan.

 [Check it out.](#)

## PresenterMedia

PresenterMedia is a leading design service for Microsoft PowerPoint presentations.

We have a subscription allowing us to download customisable PowerPoint templates, animations, premium 3D imagery and clipart. We can have text embedded into their animations and many of their video backgrounds.

 [Check it out.](#)

## Idefix (Q-Park drive T)

Idefix is a Q-Park drive which contains all kinds of Q-Park specific downloadable information among which;

- | Real Estate drawings et cetera
- | Manuals
- | Icons
- | Pictures
- | Presentations
- | Showcases
- | Templates

# Q-PARK TERMINOLOGY

## Q-Park Terminology dos & don'ts

Do	Don't	Term	Explanation	Domains: B2B, B2C, M (Marketing), R (Reports)
Active mobility	Pedestrianisation	Active mobility	We use active mobility to refer to cycling and walking.	R, B2B
AED		Automatic External Defibrillator	A resuscitation device placed in or near PFs.	R, B2C
AI		Adobe Illustrator	Software for graphics design	M
AIB		Association of Issuing Bodies – develops, uses and promotes a European, harmonised and standardised system of energy certification for all energy carriers: the European Energy Certificate System – EECS.	Some Q-Park entities have purchased EECS energy certificates, thus reducing their CO <sub>2</sub> footprint.	R
ANPR	LPR	Automatic Number Plate Recognition.	Important technology for PaSS. ANPR is EU English, LPR is American.	R, B2C, B2C
API		Application Programming Interface	Enables third parties to integrate pre-booking in their own websites.	R, B2C
AR		Annual Report		R
B2B		Business-to-business	B2B refers to transactions and communications between companies.	
B2C		Business-to-consumer	B2B refers to transactions and communications between companies and consumers.	
Bicycle	Bike	Bike refers to a motorbike.	We offer bicycle parking in our parking facilities.	R, B2B, B2C
Brand		Brand	A brand is a particular identity or image regarded as an asset.	M
capex	CapEx	Capital expenditure	Expenditure on acquisitions of or improvements to fixed assets, such as parking facilities	R
Carbon neutral		Carbon neutral	Carbon neutral means that any CO <sub>2</sub> released into the atmosphere from a	R

**Domains:**  
B2B, B2C,  
M  
(Marketing),  
R  
(Reports)

Do	Don't	Term	Explanation	
			company's activities is balanced by an equivalent amount being removed.	
CCPD		Corporate car park design		
CCTV		Closed-circuit television	Placed in PFs for safety and security, monitored in the QCR	R, B2B, B2C
CGS		Customer Guidance System	The CGS is the signage used in parking facilities for wayfinding. This is mostly red and green. Blue is used for EV charging signage.	
Charging point	charge-point or charge point	charging point / EV charging point	We refer to EV charging facilities as 'EV charging points' or 'charging points'.	B2B, B2C, M, R
CLA	CBA, CAO	Collective Labour Agreement, Collective agreement	Collective agreement between employers, or employers' organisations, and employees (via trade unions) regarding, for example pay, working hours, notice periods, and pensions. The legal status of CLAs differs per country.	R
Climate neutral		Climate neutral	Refers to the idea of achieving net zero GHG by balancing those emissions so they are less than or equal to the emissions that get removed through the planet's natural absorption.	R
CMS		Content Management System	A CMS is software that helps users create, manage and modify content on a website. We use Tangelo for the corporate website and Sitecore for the country websites.	
CMYK		CMYK	The CMYK colour model is a subtractive colour model, based on the CMY colour model. It	

**Domains:**  
B2B, B2C,  
M  
(Marketing),  
R  
(Reports)

Do	Don't	Term	Explanation	
			is used in colour printing, and is also used to describe the printing process itself. CMYK refers to the four ink plates used in some colour printing: cyan, magenta, yellow, and key (black). (Source: Wikipedia)	
CO <sub>2</sub>	CO2	Carbon dioxide	Carbon dioxide is the end product of complete combustion of hydrocarbons such as fossil fuels.  We use the proper chemical formula to refer to carbon dioxide.  Note: remember to check the formatting after copying 'CO <sub>2</sub> ' as the subscript formatting is often lost.	R, B2B, B2C
Control fees	CF, cf	Control fees	Parking fines as penalty for non-compliance with parking regulations in private car parks.	R, B2B
Covid	Corona, covid-10 COVID-19,	Covid	We refer to pre-Covid and post-Covid.	R
CPI		Consumer Price Index	Measure of inflation	R
CPO		Charge Point Operator	Operates EV charging points	R, B2B
CSFs		Critical Success Factors	We define CSFs as targets and objectives and measure our performance of these using KPIs.	R
CSR		Corporate Sustainable Responsibility		R
CSRD		Corporate Sustainability Reporting Directive	Reporting rules to ensure that investors and other stakeholders have access to the information they need to assess the	R

**Domains:**  
B2B, B2C,  
M  
(Marketing),  
R  
(Reports)

Do	Don't	Term	Explanation	
			impact of companies on people and the environment and for investors to assess financial risks and opportunities arising from climate change and other sustainability issues. Companies subject to the CSRD will have to report according to European Sustainability Reporting Standards (ESRS).	
CTA		Call to action	Call to action is a marketing term use for any snippet of text or button to prompt the reader into action. A CTA is usually at the end of an item. For example: Pre-book your parking space now!	M
Customer	Consumer	Customer	People cannot 'consume' our services. Our parking customers. Customer refers to B2C relationships.	R, B2B, B2C
DEFRA		Department for Environment Food & Rural Affairs	UK government body issuing emission conversion factors are for use by UK and international organisations to report on 2023 greenhouse gas emissions. [See <a href="https://www.gov.uk/government/publications/greenhouse-gas-reporting-conversion-factors-2023">https://www.gov.uk/government/publications/greenhouse-gas-reporting-conversion-factors-2023</a> ]	R
DOF		Depth of field	The depth of field (DOF) is the distance between the nearest and the furthest objects that are in acceptably sharp focus in an image captured with a camera. Also closely related to depth of	M

Do	Don't	Term	Explanation	Domains: B2B, B2C, M (Marketing), R (Reports)
			focus. DOF used in in guidelines for photography	
Drivers		Drivers	We use the term drivers for elements of strategy, for example to address business drivers such as capital, employees, technological advancement etc.	R
Dutch GAAP		Dutch GAAP	The Dutch GAAP includes the Dutch Civil Code and the Dutch Accounting Standards published by the Dutch Accounting Standards Board.	R
EBITDA		Earnings Before Interest Tax Depreciation and Amortisation	An measure of profitability.	R
EECS		European Energy Certificate System	European Energy Certificate System is an integrated European framework for issuing, transferring and cancelling EU energy certificates.	R
EPA		European Parking Association		R, B2B
ERM		Enterprise Risk Management		R
ESG		Environmental, social and governance	Designed to help investors compare how companies score on the environmental, social and governance metrics and standard.	R
ESPA		European Standard Parking Award		R, B2B
ESRS		European Sustainability Reporting Standard	In April 2021, the European Commission adopted a legislative proposal for a Corporate Sustainability Reporting Directive (CSRD) that requires companies within its scope to report using a double materiality	R

**Domains:**  
B2B, B2C,  
M  
(Marketing),  
R  
(Reports)

Do	Don't	Term	Explanation	
			perspective in compliance with European Sustainability Reporting Standards (ESRS) adopted by the European Commission as delegated acts.	
EU		European Union		
EU Green Deal	Green deal	Green deal	A plan to make the EU's economy sustainable, turning climate and environmental challenges into opportunities, and making the transition just and inclusive for all.	R
EV	electric car	Electric vehicle		R
EV charging	car charging	EV charging	We provide EV charging in our PFs for our customers' convenience to recharge their car while parking.	B2B, B2C, M, R
EV charging card	EV charge card	EV charging card	The payment card an EV owner presents to the EV charging point to starts their charging session.	B2B, B2C, M, R
EV charging point	charge-point or charge point	EV charging point or charging point	We refer to EV charging facilities as 'EV charging points' or 'charging points' .	B2B, B2C, M, R
FACU/FACP		Fire Alarm Control Unit, Fire Alarm Control Panel	Part of the fire safety installation in a PF.	R, B2B
GAAP		Generally Accepted Accounting Principles		
GDPR		General Data Protection Regulation	Applicable since May 2018. This is a legal framework that sets guidelines for collecting and processing personal information from individuals who live in and outside of the European Union (EU).	R, B2B, B2C
GHG		Greenhouse Gas	Greenhouse gases (GHGs) include carbon dioxide (CO <sub>2</sub> ), methane and sulphur dioxide.	R



Do	Don't	Term	Explanation	Domains: B2B, B2C, M (Marketing), R (Reports)
GHG Scope 1, 2 and 3		Scope or Scopes 1, 2 and 3	<b>Scope 1</b> covers direct emissions from owned or controlled sources. <b>Scope 2</b> covers indirect emissions from the purchase and use of electricity, steam, heating and cooling. By using the energy, an organisation is indirectly responsible for the release of these GHG emissions. <b>Scope 3</b> includes all other indirect emissions that occur in the upstream and downstream activities of an organisation.	R
Goodwill			Used to express that portion of the market value of a company that is not directly attributable to the assets and liabilities. Goodwill (or badwill) usually arises at the time of acquisition and is considered as the added value of a company over and above the net worth.	R
GRI			Global Reporting Initiative: draws up worldwide guidelines for sustainability reporting, including meeting new CSRD requirements.	R
GSM	Mobile phone	Global System for Mobile Communications		R, B2B, B2C
Hire	Rent	Hire	Hire is used for items which are transportable	R, B2B, B2C
			Rent/rental – mainly used for immovable items, such as property	
HRM	HR	Human Resources Management		R

Do	Don't	Term	Explanation	Domains: B2B, B2C, M (Marketing), R (Reports)
ICE		Internal Combustion Engine	Used when comparing EVs with other types of vehicles.	R
ICT	IT	ICT	Information and communications technology.	R
ICT	IT	Information and Communication Technology		R
Idefix		Idefix	Central T drive where manuals, approved visuals, templates etc. can be found.	
IFRS		International Financial Reporting Standards		R
ISO		International Standards Organisation		
ISO		International Organisation for Standardisation		R
KPIs		Key Performance Indicators	We use KPIs to measure our achievement of CSFs (targets and objectives).	R
Lease	Rent	Lease	A legal agreement by which the owner of an object (e.g. plot of land, parking facility, vehicle) allows someone else to use it for period of time in return for money.	R
LED		Light Emitting Diode	LED lights consume far less electricity than other types of lights. In 2018 and 2019 we invested to replace fluorescent lighting in our PFs with LED lighting, making considerable savings in our GHG emissions and CO <sub>2</sub> footprint.	R, B2B, B2C
Like-for-like	LFL	Like-for-like	Is used to indicate growth adjusted for businesses which have been bought or sold during the year.	R

**Domains:**  
B2B, B2C,  
M  
(Marketing),  
R  
(Reports)

Do	Don't	Term	Explanation	
LTP		Long-term parking	Long-term parking includes season tickets.	R, B2B
Markets, countries	Geographies	Markets, countries	<p>We operate in different countries, each with its own market characteristics.</p> <p>Geographies refers to a geographical area or region. We do not use geographies, area or region to refer to our markets.</p>	R, B2B
Mode of transport	transport methods, transport mode	Mode of transport	Mode of transport refers to the way in which people and goods can be transported. At Q-Park we connect with other modes of transport at our mobility hubs. These include bus, tram, metro, train, and bicycle.	R, B2B, B2C
Motorists	Drivers	Motorists	We use the word motorists to refer to our parking customers.	R, B2B, B2C
Moped / motor scooter	Scooter	Moped, motor scooter	<p><b>False friend</b> A scooter in English is a step in Dutch. A step (NL) or scooter (EN) has two small wheels and low platform to stand on. Usually not powered, except an e-step /e-scooter.</p> <p>A scooter (NL) moped (EN) has two chunky wheels, smaller in diameter than bicycle wheels, a seat and a platform to rest your feet on. A motor scooter is powered and may be electric. In Italian it would be a Vespa.</p>	R, B2B, B2C

**Domains:**  
B2B, B2C,  
M  
(Marketing),  
R  
(Reports)

Do	Don't	Term	Explanation	
Municipality, city, district		Municipality, city, district	We partner with local government authorities; these may govern a city, municipality or smaller urban district.  Use the term (city, municipality, district) appropriate to the situation.	R, B2B, B2C
Neighbourhood	Locality	Neighbourhood	We use neighbourhood to refer to a district or community within an urban area.	R, B2B, B2C
Net zero	Net-zero	Net zero	Net zero refers to the amount of greenhouse gases that are removed from the atmosphere being equal to those emitted by human activity.	R
NGO		Non-Governmental Organisation		R
Number plate	License plate	Number plate	Number plate is EU English, license plate is the American term.	R, B2B, B2C
opex	OpEx	Operating expenses	Cost incurred in the normal business operations	R
P&L		Profit and loss		R
P+R	P&R	Park + Ride	A parking facility with public transport connections that allows motorists to leave their vehicles and transfer to a bus, rail system (rapid transit, light rail, or commuter rail), or carpool for the remainder of their journey.  We use the plus-sign ... + ... for P+R (Park+Ride) to align with public parking signs We use the and-sign ... & ... mostly	R, B2B, B2C

**Domains:**  
B2B, B2C,  
M  
(Marketing),  
R  
(Reports)

Do	Don't	Term	Explanation	
Partner	Client	Partner	Partner refers to all B2B relationships  Partners include:  <ul style="list-style-type: none"> <li>  suppliers of PMS, EV charging services, mobility hub participants;</li> <li>  landlords, developers and municipalities, as Q-Park provides a service to these entities.</li> </ul>	for internal combinations (Pay & Display for example)  R, B2B
PaSS	Pass, pass, PASS, PasS	Parking as a Smart Service	Q-Park Parking as a Smart Service (PaSS) is an evolutionary innovation combining ANPR technology with digital payment solutions, a QR code, Q-Park's proprietary Back Office Calculation (BOC) and Parking Management System (PMS) at access and exit points.	R, B2B, B2C
Pay zone	Payment area, Payment zone	Pay zone	Refers to the area in a parking facility where customers who took a ticket on entry must pay before returning to their car and driving to the exit.	R, B2B, B2C
PCI DSS		Payment Card Industry Data Security Standard	Standard for processing credit card and debit card transactions.	R
Pedestrian access	Pedestrian entrance/exit	Pedestrian access	Use this to refer to the doors and zone where customers enter the parking facility on foot.	R, B2B, B2C
PF, PFs	facility, facilities	Parking facility, Parking facilities	We prefer the term parking facility because we offer space to more than just cars, i.e. bicycles, coaches etc.	R, B2B, B2C

**Domains:**  
B2B, B2C,  
M  
(Marketing),  
R  
(Reports)

Do	Don't	Term	Explanation	
			Never use facility/facilities on its own.	
			However, use parking facility in B2B and internal communications, use car park in B2C communications.	
PHEV		Plug-in Hybrid Electric Vehicle		R
PMS		Parking Management System		R, B2B
PNG		Portable Graphics Format	A PNG file is a type of image file.	
POD		Points of Difference	For effective marketing we have to convey our PODs and POPs.	M
			A POD tells customers why our product or service is their best choice compared to the competition offering.	
POIs	Tourist attraction	Points of interest	We list POIs per city on our country websites to help customers find a PF near to their final destination.	R, B2B, B2C
POP		Points of Parity	For effective marketing we have to convey our PODs and POPs.	M
			A POP tells customers that our services meet their needs.	
PPP		Public-Private Partnership	A cooperation between government bodies and private parties is a prerequisite to keep inner-city areas accessible through well thought out parking policy. We work in Public Private Partnerships and not in any other form of public partnership.	R, B2B
PRIS		Parking Route Information System	A parking route information system consists of traffic signs to direct motorists to car parks in	R, B2B

**Domains:**  
B2B, B2C,  
M  
(Marketing),  
R  
(Reports)

Do	Don't	Term	Explanation	
PRMs	disabled	Persons with Reduced Mobility	an urban area. The signs may include the number of vacant space in a PF.	R, B2B, B2C
Programme	Program	Programme	Q-Park Programmes, such as the LED Programme, Cybersecurity Programme are, as always, written in British English.  In British English 'Program' always refers to something related to computing i.e. software program. US English does not make this distinction.	R, B2B, B2C
PS, PSs	place, spot, parking place, parking spot	Parking space, Parking spaces	We provide space for parking – parking spaces, that is our core business.  Spots may be perceived as a stain, i.e. a floor has spots.	R, B2B, B2C
QCR		Q-Park Control Room	The international central control room which is linked to the parking facilities via intercom.	R, B2B, B2C
QMH	hub	Q-Park Mobility Hub	A parking facility where different transport modalities and services are offered to commuters, visitors and/or residents; where people can interchange between car, public transport and/or shared mobility and micromobility options, including bicycle parking, shared micromobility services, rental car services; equipped with EV charging points,	R, B2B

**Domains:**  
B2B, B2C,  
M  
(Marketing),  
R  
(Reports)

Do	Don't	Term	Explanation	
Q-Park	q-park, q-Park, Q Park	Q-Park	and may include fast-charging services; connected to a digital ecosystem, enabling ANPR, pre-booking, parking app options and/or season ticket options.  Q-Park is written with capital Q and P and a hyphen in between. NEVER split Q-Park over two lines	R, B2B, B2C
RCF		Revolving Credit Facility		R
Revenue		Revenue	We use revenue (not turnover) to describe our income from normal business operations.  We don't use turnover – that refers to selling goods – we sell services.	R
RGB		RGB	The RGB colour model is an additive colour model in which red, green, and blue light are added together in various ways to reproduce a broad array of colours. The name of the model comes from the initials of the three additive primary colours, red, green, and blue. (Source: Wikipedia)	
SDGs		United Nations Sustainable Development Goals		R
Season ticket	Subscription	Season ticket	In EU English, a <i>season ticket</i> is something you go to (theatre, football, parking)  A <i>subscription</i> is something that comes to you (magazine, Netflix)	R, B2B, B2C
Sharing		Sharing	We partner with car sharing and bicycle sharing scheme	R, B2B, B2C



Do	Don't	Term	Explanation	Domains: B2B, B2C, M (Marketing), R (Reports)
			operators, particularly in our mobility hubs.	
SLA		Service Level Agreement		R
SMP		Strategic Mobility Partnership		R, B2B
STP		Short-term parking	This refers to single parking transactions.	R
SUMP		Sustainable Urban Mobility Plan		R, B2B
SVG		Scalable Vector Graphics	SVG is a file format for images.	
Tenor		Tenor	The length of time remaining before a financial contract expires	R
TOMA		Top of Mind awareness	Top of mind awareness is a key concept in marketing and market research	M
Transport	transportation	Transport	We use transport, the term transportation is the American term.	R, B2B, B2C
Urban area	Urbanisation	Urban area	We use urban area to refer to cities and towns. The term urbanise, urbanisation means to transform a rural area into an urban area.	R, B2B
Vehicle entry/exit zone	Entry/exit	Vehicle entry zone Vehicle exit zone	Use these terms to denote vehicle access and exit <b>routes/areas</b> in the parking facility.	R, B2B, B2C
VEXPAN		VEXPAN	Platform for parking in the Netherlands (vexpan.nl)	R, B2B
VMS		Variable Message Sign	VMS are used within parking guidance and information systems to guide drivers to available car parking spaces. Source: Wikipedia	
Wayfinding		Wayfinding	Wayfinding signage in our PFs identifies the various facilities present and helps motorists and	R, B2C

**Domains:**  
B2B, B2C,  
M  
(Marketing),  
R  
(Reports)

Do	Don't	Term	Explanation	
			pedestrians find their way to the exit, payment zone etc.	
			Wayfinding uses the CGS signage.	
WDQ		We Develop Quality	A slogan we use at Q-Park to brand our expertise articles	M
Western Europe	West Europe		Use 'western Europe' when referring to the part of Europe where Q-Park operates. Avoid using 'west' as this is perceived as the opposite of 'east'	
Zone		Zone	Use zone to refer to specific areas of a PF, e.g. EV charging zone,  bicycle parking zone	R, B2B, B2C

---

# MARKETING COMMUNICATIONS CODE

Q-Park adheres to the ICC Advertising and Marketing Communications Code - a globally-applicable self-regulatory framework, developed by experts from all industry sectors worldwide. The Code is the backbone of the global advertising and marketing industry.

The Code seeks to protect consumers by clearly setting out the 'dos and don'ts' for responsible marketing to ensure legal, honest, decent and truthful communications and practices. The Code sets high standards for a full range of marketing activities, including digital marketing communications with measures to protect children and consumer privacy.

 Find detailed information on the ICC Advertising and Marketing Communications Code [here](#).

# tone of voice



## Recommendations

All Q-Park communications should be clear and concise, and easy to understand at a glance - for visuals, and on first reading for texts. Follow your country/language 'plain language' guidelines.

- | **Use inclusive language** so not to offend
- | **Use the active voice** to communicate in a direct, concise and dynamic tone
- | **Be positive** and emphasise what **can** be done
- | **Give credit** for sources and images used and respect copyright

## Writing for the digital world

Text for web pages should be brief and to the point.

- | One page deals with a single topic or one specific key word
- | Use maximum 200-250 words per screen, yet provide complete information
- | Use short sentences but do not oversimplify

Website visitors scan rather than read.

- | Structure the information using headings and subheadings
- | Always mention in the 1st heading of your text the key word of the page
- | Ensure that headings, paragraphs and colours are used consequentially
- | Use bullets to convey information concisely

- | Use FuturaTDem to emphasize (never bold)

Make the text inviting and attractive:

- | Use the key word of the page in the title
  - | Keep titles brief (maximum 88 characters)
  - | Avoid superlatives in titles
- | When placing links in text, inform visitors what they will find

## Quality check

Use this checklist before publishing or sending out anything you have written.

- | Is the spelling and grammar correct, use the spelling checker but don't rely on it
- | Is the text well structured and logical
- | Is everything covered
- | Is the content accurate
- | Is the level of detail appropriate
- | Is there irrelevant information that can be omitted
- | Is the communication:
  - | accurate
  - | specific
  - | concise
  - | consistent
  - | unbiased

# PUBLIC RELATIONS

---

## PRESS / MEDIA PROTOCOL

### Introduction

As we are listed on a semi-public stock exchange and we have many bond investors with a variety of needs and questions, we need to ensure that the board and our shareholders are not 'surprised' by what's happening in the group.

This protocol outlines the governing of all external communication, and all proactive and reactive engagements with members of the media. All third party interactions, related to external communication, are part of this protocol too.

- I Proactive: (including but not limited to) news items, press releases, social media messages.
- I Reactive: (including but not limited to) quotes, statements, responses, inquiries, interview requests.

A clear and consistent positioning of Q-Park as a company and brand is essential to our business. Therefore, it is vital that Q-Park speaks with one voice and that all media interactions, whether verbal or in writing, whether online, offline or for broadcast are **cleared** and in line with Q-Park's messaging.

In order to guarantee consistency of messaging throughout the group, all those who act on behalf of Q-Park should check and consult Brand, Communications & CSR at corporate headquarters first, before engaging with any external communication, media outlet or journalist.

### Scope of protocol

The protocol applies to all media messaging and materials, which include but are not limited to (i) press releases, (ii) news items, blogs, white papers and opinion pieces; (iii) media interviews for/in any publication; (iv) media requests for commentary, media quotes and statements; (v) media background calls/off-the-record engagements; (vi) media engagements and speaker opportunities at external events; (vii) paid for advertorials and (viii) social media posts.

To be sure, the following messages are exempt for clearance:

- I Promotional (i.e. pre-booking campaign, app campaign, ...)
- I Operational (i.e. road is closed, parking decks are closed for renovation, ...)
- I HRM (i.e. job openings, employee social activities, ...)

### Handling media enquiries

Any incoming media enquiries concerning the reserved issues can simply be passed on to Q-Park corporate headquarters by using the following guideline.

#### Basic guidelines for dealing with incoming media enquiries

Those who act as spokesperson on behalf of Q-Park should only comment directly to questions from media if the enquiry does (i) not concern a reserved issue and (ii) they are 100% sure of the answer. When in doubt, please use the following statement:

**“I am not able to answer your question at this time. However, I have taken note of your enquiry and will get back to you on this as soon as possible.”**

In all such circumstances, please use the following basic guidelines:

1. Never speculate, never immediately confirm/deny or provide additional commentary.
2. Take notes of their questions, publication window and contact details.

3. Use the call to gather information on what they seem to know and what their sources are.
4. Mention that he/she will be called back if applicable/as soon as possible.
5. Consult Brand, Communications & CSR for guidance and alignment on appropriate follow-up.
4. Apply cleared approach, messaging and materials whether for reactive or proactive media purposes.
5. Keep track of publications, share media coverage and feedback with Brand, Communications & CSR.

### Clearance of media messaging and materials

Prepared media messaging and materials are to be **cleared** by Brand, Communications & CSR at Q-Park corporate headquarters in advance. Please use [sacha.oerlemans@q-park.com](mailto:sacha.oerlemans@q-park.com) to inform the team in a timely manner and accompanied by a basic English translation.

Please bear in mind that the team may require up to a maximum of 48 hours to respond with feedback, unless otherwise agreed. For media enquiries urgent requests, please indicate why the request is urgent so the team can take this into account and/or reach out to the team directly at **+31 627 830 359**.

When in doubt, please do reach out to Brand, Communications & CSR for advice and guidance on the matter. It is always better to be safe than sorry.

### Basic procedure for clearance of media responses, outings and materials

Please apply the basic following steps:

1. Send a brief description of the media issue/case at hand and envisaged window, your suggested approach and messaging as well as any related draft PR materials to
  - a. [sacha.oerlemans@q-park.com](mailto:sacha.oerlemans@q-park.com) (if required add a basic English translation).
  - b. If the go-ahead is needed urgently, call or WhatsApp.
2. Where appropriate jointly discuss, review and/or align approach, messaging and materials.
3. Process guidance and/or feedback (if any) from Brand, Communications & CSR for final clearance.

Prepared media messaging and materials should typically be assessed against criteria, such as (i) whether or not it relates to a reserved issue; (ii), impact on corporate reputation; (iii) any business and commercial sensitivities, (iv) any financial, operational risk and/or cybersecurity sensitivities, (v) insider trading and information liabilities (e.g. forward looking statements); (vi) overall alignment with key messaging; and (vii) general quality of approach and materials.

### Reserved issues

Q-Park has identified several topics which have been classified as *reserved issues*. Media engagement with regard to these reserved issues should typically reside with Q-Park corporate headquarters, but may - where appropriate - be (partly) delegated to local teams or certain individuals within Q-Park.

Our reserved issues list includes the following topics: (i) corporate strategy; (ii) mergers & acquisitions (iii) financial results; (iv) capital position and liquidity related matters; (v) shareholder, board and governance related issues, (vi), health and safety related issues, and (vii) cybersecurity and datasecurity related issues.

If you are unsure about what needs to follow this protocol (and what not) ... it is better to be safe than sorry, so share more (not less).

If this protocol needs to be forwarded to other colleague(s), please do so and inform Corporate Communications Manager as to whom needs to be included for future reference.

# GUIDELINES

## Guideline for approval

### About this guideline

As each country gradually focuses more on creating its own local Sustainable Mobility Partner (SMP) content (press releases, opinion pieces, local website cases,...), a clear workflow helps to get each content piece approved by Q-Park Corporate smoothly. Please note that you are free to create any piece of content you like – these guidelines are only here to make your content process easier and support you when necessary.

### Process & timeline

- I Content idea
  - I Once you have decided on creating a content piece, please share the concept/objective of the content with Q-Park Corporate via e-mail. You don't need approval before starting with the creation, this step is only to inform Corporate about your initiative and provide support if needed.
- I Creation of the draft
  - I We have a guideline available to strengthen consistency in SMP content & narratives.
  - I We have a guideline available to create a strong SMP case story (celebrating success).
  - I If you need support from your local PR agency (or freelancer), please feel free to do so.
- I First draft finished
  - I Please check if you have consulted the guidelines to ensure style and language alignment.
  - I When sharing your draft, grant Q-Park Corporate colleagues some time for feedback/approval.
- I Feedback process
  - I Q-Park Corporate aims to provide feedback on your draft within 1 to 3 business days.

- I You may iterate/discuss the draft with Corporate as much as you need.
- I You can save the final approved document here and inspire international colleagues.

### Do not forget

We have a press release protocol in place as we are a semi-public company. Please review this protocol prior to any publication in scope.

## Guideline for consistency

### Introduction

In order to communicate consistently, both locally and internationally, it's important to always use the right corporate Sustainable Mobility Partner (SMP) wording, tone of voice and visual style. This document gives an overview of which wording and formulations to use, and which not to use. Note that this is a British English dictionary, to be translated (localised) for use in your specific country / language(s).

Your localised dictionary will help you to align content like news articles, press releases and social media posts with the SMP narrative and Q-Park language, which fits into our decentralised content process philosophy. Of course, support from Q-Park Corporate is always available.

Please make sure to share your local version of this document with:

- I relevant colleagues in your organisation, and to especially remind the people who communicate externally to update and adhere to it;
- I new employees (make it a part of the onboarding process);
- I external suppliers like agencies and/or freelancers if you have any.

### Brand identity

Using the Q-Park Brand Identity elements correctly protects, maintains and increases the value of the Q-Park brand and distinguishes it from competitors.

Please consult the Q-Park Brand Identity website to find and correctly apply:

- | Our name, logo, colours, shapes, visual building blocks, other visual elements in our parking facilities, services and promotions.
- | Our language in communications.
- | Our international consistency in both tangible and digital materials.
- | Word, Excel and PowerPoint templates.

### Corporate SMP dictionary

10 most important wordings

- | Parking facility (PF) – NOT car park or car accommodation as in some PFs we facilitate more than cars such as bicycles, coaches, city logistics ... et cetera.
- | Active mobility – NOT cycling and walking / pedestrianisation.
- | Bicycle – NOT bike; as a motorcycle is often referred to as bike.
- | Motorists – NOT drivers; motorist refers to our parking customers and drivers refers to what drives us and is often used to explain strategic elements.
- | EV charging – NOT car charging | Number plate – NOT license plate as that's the American term;
  - | Number plate belongs with the European Automatic Number Plate Recognition (ANPR)
  - | License plate belongs with the American License Plate Recognition (LPR)
- | P+R or Park + Ride – NOT P&R
- | Urban area – NOT urbanisation, we use urban area to refer to cities and towns. The term urbanise, urbanisation means to transform a rural area into an urban area.
- | Customer – NOT consumer: a parking space cannot be consumed (like food), and with customer we refer to all Business-To-Customers (B2C) relationships.
- | Partner – NOT client; partner refers to all Business-To-Business (B2B) relationships, for example suppliers of EV charging services, mobility hub participants, etc.

### Tone of voice

This is highly dependent on your markets, so please include all relevant local information. For example:

- | Which groups do you address with 'formal' (Sie, vous, u, ...) and 'informal' pronouns (du, tu, je/jij, ...).
- | Specific inclusive language choices (with regard to local sensitivities for example).

In general, pay attention to the following guidelines in all languages:

- | Active in favour of passive: 'Q-Park has opened a new mobility hub in X' - NOT 'A new mobility hub was opened by Q-Park'
- | Short sentences in favour of long ones.
- | Avoid repetition and needless adjectives.
- | Seeing our B2B relations as partners and not clients is all about partnerships – doing things together. It's also in the way we talk about them in case studies. For example: 'we developed the mobility hub in close collaboration with the city – NOT 'for the city or 'commissioned by the city'.

## Guideline for a strong SMP case story

### About this guideline

As a Sustainable Mobility Partner (SMP), Q-Park achieves great things for municipalities, their residents and visitors. It's important to inspire a variety of stakeholders (especially local decision makers).

This document helps you to initiate and create strong case stories locally. Of course, as with all content, please inform Q-Park Corporate in accordance with our PR protocol.

### Some instructions for a strong Q-Park case story

- | Think outside-in: the goal of a case story is to convince local authorities that we are a key partner to have at the table when tackling mobility challenges. This means we always approach the story from their (outside) perspective: with which challenge did the



municipality struggle and how did Q-Park fix that?

- | Include all key aspects which decision makers consider when choosing a mobility partner, for example:

- | The actual solution we brought to the table, with a focus on our strategic and creative SMP role.
- | The way we acted as a partner in the collaboration (advice, flexibility, expertise, finances, respect for agreed timings and community needs, and delivery standards, ...).
- | The results, preferably in KPIs, that resonate with stakeholders (public satisfaction rates, decrease in unwanted car movements, decrease of dangerous traffic situations, increase in EV charging points, increase in usage of bicycle parking, increase in shared mobility partnerships, decrease in amount of cars parked on the street...).

- | Think of one overall aspect which stands out (and attracts): what makes this project unique? This can be a very difficult challenge for example regarding mobility or construction, or a hugely prestigious location. Use that as a key part of the introduction.

- | Maximise the inclusion of, and consistency with, our SMP Message House.

- | Let the customer (or municipality, developer, partner) tell the story for you: add at least one quote or, if possible, tell different parts of the story in the form of quotes (an overall interview format is also an option): this adds to the credibility of the story and makes the target audiences relate to it more.

- | Don't think 'chronology' by default, a strong case story is not told from A-Z. For example: leave (if at all relevant) information about the initial prospecting/sales phase of the parking facility for the end. This can be relevant information but only when the reader is convinced by the case itself. The structure hereafter will help you with that.

- | Strong title: make sure this attracts the attention of your target audience.

- | Introduction: this is where the reader decides if this story is what they thought it would be, so make sure it already points to the key elements, like the challenge and the result.

- | The actual story, the following order merely serves as a tool to help you tell a logical and attractive story.

- | Start by explaining the municipality's initial need (from their perspective):
  - | Question to answer: Which goal or challenge did they have?
  - | Example: "create additional parking space while decreasing on-street parking."

- | Then explain the overall solution:

- | Question to answer: Which solution did Q-Park as an SMP propose and how did that advice/decision process go (dialogue, ...)?
- | Example: "Q-Park suggested to renovate an existing parking facility and incorporate EV charging points and car-sharing providers to offer a range of mobility solutions. Re-designing existing real estate is a more sustainable and often faster solution than new build.

- | Describe the relevant (things that our decision makers care about and/or that strengthen our SMP positioning) project information.

- | Question to answer: How did we execute the solution and how did we collaborate with the municipality and other partners?

- | Example: "The former Q-Park Centre in The Hague was renovated, partnerships were found to ensure fast EV charging stations and car-sharing solutions for our customers. Together with the municipality we ensured proximity

- 
- to public transport station and created easy to use products for Park + Charge and Park + Ride needs".
  - I Key results:
    - I Question to answer: How did the solution of Q-Park contribute to the local mobility and parking needs?
    - I Example: "With this new mobility hub, Q-Park managed to create xxx new parking spaces underground, creating more shared space with play grounds, trees and lanes for pedestrians and cyclists. Car movements were reduced around the city and the general urban liveability in the city increased."
  - I The collaboration:
    - I Question to answer: How did the municipality and end-customer experience the collaboration with Q-Park (focus on key SMP aspects)?  
Page 3 of 3
    - I Example: "With this new mobility hub it is easier for customers to make informed decisions and continue their journey in a more sustainable way. There are solutions for residents and cyclists, and it is easy for mobility partners and local businesses to partner with Q-Park. They obtain much needed space and/or obtain customised solutions to fulfil their needs.
  - I Only then, add (if relevant) other information like:
    - I The prospection/sales phase (why was the municipality convinced to choose Q-Park?) or other information. Example: "The city chose Q-Park for this project, because it was very important to preserve some specific historic elements around the parking facility. Q-Park is specialised in this kind of construction."
    - I Next steps (if any): Which other activities and phases are there in the project and which basis has the past phase layed for that?
    - I Q-Park motivation: Why did Q-Park want to execute this project?
    - I Finish with a Call-To-Action (CTA): provide links to other cases for more inspiration and make sure the reader knows how to contact you (in a website case, you can include an additional CTA at the start and/or in the middle of your case as well).
- Feel free to connect with Q-Park Corporate if you need any help with the creation of the case story. If you need support from your local PR agency or freelancer, please feel free to do so.

# PHOTOGRAPHY

---

## Photography for commercial purposes



### Images

Style images: movement, dynamic, open, bright, honest, real-life

- | Parking facility: clear, clean, bright, not empty.
- | Persons: people preferably do not look straight into the lens but appear to be photographed 'in passing', as a reportage photography.
  - | If an image of a person accompanies an article that is not about that person, then they must be unrecognisable.
  - | The image may be dynamic (motion-blurred) to achieve this.

- | Images of large crowds may be sharp.

### Dos

- | Place multiple images flush against one another, or with a space in between that continues logical alignment.
- | Images should always be aligned.
- | Images may be placed flush against (not overlap) the red bar.
- | Detached images are allowed to be placed anywhere in the type area.

## Photography in parking facilities



For photos in, around or about our parking facilities we recommend working with a professional photographer. Bear in mind that the main aim of hiring a professional is to obtain visuals that can be used for as many applications as possible.

### Guidelines

#### Time of visit

The most usable photos of parking facilities are made when the parking facility is in use and the majority of parking spaces are occupied.

#### Checklist

In order to achieve this 'best result' it is important to fine-tune the time of visit with the photographer. Criteria for timing a photographer's visit include:

- | Before the start of any refurbishment works issue the 'Before' photoshoot.
  - | Make note of the exact location and camera settings so that the same shot can be taken when refurbishment is complete, thus creating a set of before and after visuals.
- | Parking floors and pedestrian areas are clean and all elements function properly:

- | no dust on floors, no random litter, no litter visible in bins;
- | no broken lights;
- | no temporary signage, tape lines, loose cables, barriers or fencing, et cetera.

- | Visuals are preferably taken in the direction of the traffic flow so that signage for motorists and pedestrians is visible. Try to avoid 'no entry' or other prohibition signs.
- | Try to capture customer and operational activity.
- | Make sure that customers and/or employees photographed give their permission to use their portraits for international communication purposes. See the suggested consent form for in- and external use in the appendix.
- | A theme checklist can be downloaded.
  - | It contains themes for visuals we need.
  - | Approved visuals can be easily categorised for Idefix.

Note: number plates captured must be made illegible to respect privacy.

## Guidelines for photographers

### Dos and don'ts

In general, parking facilities have low ceilings which complicate the photoshoot and make shots taken with wide-angle lenses look very artificial. Consider the following when planning and taking photos in our parking facilities:

- I We prefer photos not to be taken with a wide-angle lens so that a more realistic image is portrayed.
  - I Vertical elements such as columns and walls must appear vertical
  - I Photos should be taken with the lens pointing horizontal to prevent visuals appearing tilted.
- I Overview photos should be captured with reduced depth of field (DOF) settings.
- I Close ups, details or action photos can be captured with higher DOF settings to emphasise the theme of the visual.
- I Be cautious when taking photos with a slow shutter speed, or long exposure, and thus creating a motion effect. Always take the same shot with a fast shutter speed, short exposure, without motion.
- I Avoid taking high contrast shots as Q-Park wants the colours to be as realistic as possible.

Some examples to clarify our wishes: dos (Y), don'ts (N) and points for extra attention (!).



- N Walls and columns are 'tilted', which looks artificial
- N Picture taken from too high a position, lower the camera
- Y Elements visible are good (lighting, ventilation, former colour scheme)



- Y Walls and columns are vertical
- N Visual has very high contrast; ceiling seems black and walls seem white
- N Parking deck is empty
- N Visual is shot against the traffic flow with prohibition sign visible



- N Visual is shot with a wide-angle lens, which creates unrealistic ratios (A1 frame seems square)
- Y Good example of 'house style' elements and materials in stairwell



**N** Visual is shot with a wide-angle lens, which creates unrealistic ratios  
**Y** Good example of occupied parking floor  
**!** Visual is shot against traffic flow, although no prohibition signs are visible



**Y** Very usable visual, showing: Occupied parking floor with cars, customer movement, colour scheme and lighting



**N** Empty parking deck --> time of visit too short after opening?  
**Y** Elements visible is good (lighting, signage, colours, column free)  
**N** Visual is shot against the traffic flow with prohibition sign visible.



**N** Visual is shot with a wide-angle lens, which creates unrealistic ratios  
**Y** External signage is included and well visible  
**Y** Elevations which show the function of the building.



**Y** Good example of DOF usage

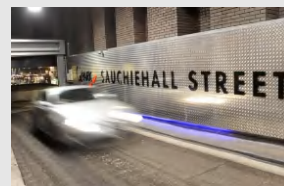

**!** Be cautious when using slow shutter speeds for visuals, always capture same visual without movement  
**N** Blue light fitting is partially defect, make sure a maintenance check-up is done prior to photoshoot



**N** Wide-angle lens creates unrealistic ratio of blue P-sign on the corner

**N** Light fitting in staircase level 1 is defect and should have been repaired prior to photoshoot

**Y** Visual taken by night time to emphasise entrance

### Capturing the Q-Park themes

When a photographer is commissioned to make visuals of a parking facility, please ensure that all themes are captured. The themes concur with IDEFIX directories.

- | Members of the Real Estate Project Team who were involved during construction and/or renovation are familiar with the site and may have relevant information about points of attention.
- | Marketing managers should be contacted prior to the photoshoot.

### Building structure

- | The physical structure of the building should be captured (e.g. concrete or steel columns, beams, floor slabs) .





### Entrance – Motorists

- Directional signage (street signage/PRIS) and house style portals or gantry signs at the parking facility entrance.



### Entrance - Pedestrians

- Show all car park access options. Include house style signage directing customers towards these entrances (e.g. stairs, lifts, escalators).



## External design

- | The parking facility exterior in its surroundings is often an architectural challenge and makes good publicity material.



## House style examples

- | Typical house style elements are highly appreciated. They should be captured on the visuals (in overviews with their surroundings as well as in close up photos).



### Mechanical and electrical (M&E) systems

These visuals are useful to help describe the M&E requirements in parking facilities.



### Internal Design - Motorists

Overviews and details of signage, floor coating and parking deck(s).



## Internal Design - Pedestrians

The way pedestrian entrances are designed (and indicated) is very important as each solution is designed per project, but within our house style.

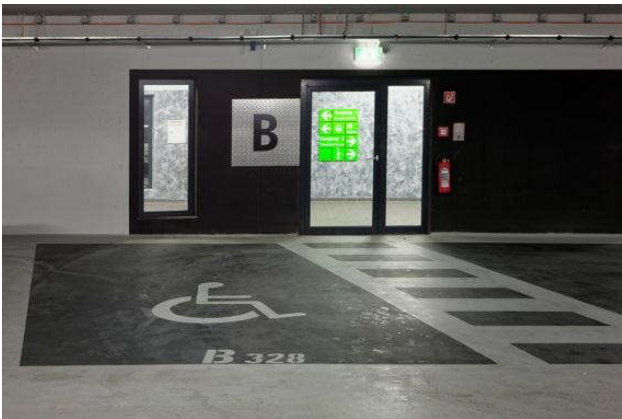

Include visuals of the main entrance and access to other floors, such as lifts, stairs and escalators. Be sure to capture the design, signage and materials used too. Customer activity in these areas is very much appreciated.



### Lodge and hosts

- | The lodge areas are always typical and should reflect our customer friendly approach.
- | Interaction between customers and Parking Hosts (in Q-Park clothing) are highly appreciated.
- | Q-Park service teams (in Q-Park clothing) in action are important to capture.

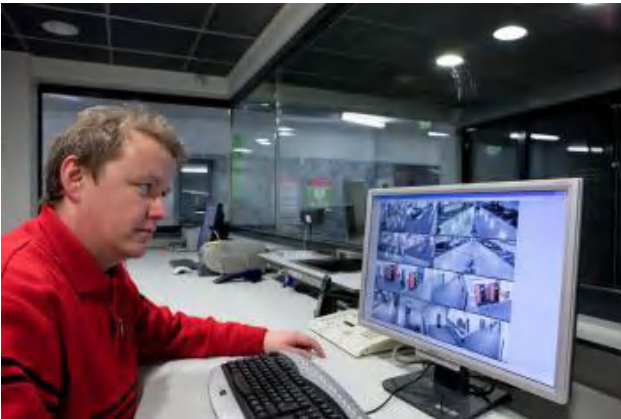

### Parking equipment

- | As part of the house style and to stand out in its surroundings, our parking equipment is **red**.
- | A great deal of effort is put into the positioning of the equipment and how it is integrated into the structure.
- | Access and exit barriers, pay stations and entrance door readers should all be photographed showing their surroundings.



## People

- In addition to visuals of parking customers we also require pictures of people in the vicinity of the parking facility (e.g. people in shopping centres, offices, hospitals, using public transport, et cetera). This is an excellent way to visualise activity in and around the parking facility .



## Services

- The services we offer vary from friendly on-site employees, toilets, AEDs, umbrellas, jump leads, car valeting, electric vehicle charging points, cleaning, payment options, to support from the QCR. It is important to capture the services available.

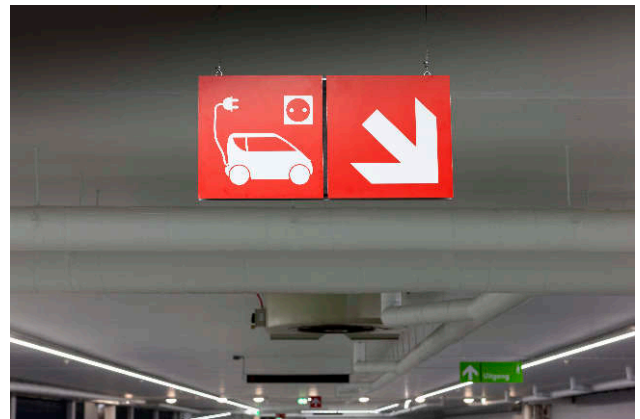

- Recognisable Q-Park fleet is also a relevant part of our services.



## Special features

- Some parking facilities have architectural features, archaeological excavations, green walls or extraordinary elements, capture them as they are highly appreciated by Business Development and other commercial activities.



### Surrounding area

- The surrounding area is as important as the parking facility itself. Squares on top of underground parking facilities, shopping centres, special points of interest or attractions to visit in the vicinity are to be included in the photoshoot.



### Traffic signs (country specific)

- Specific on-street signage should be captured too, for example showing parking routes and/or numbers of vacant parking spaces.

Other themes to consider:

- Communication tools
- CSR events and activities
- Pricing strategies
- Promotional activities
- Training

### Photos on IDEFIX

As we share many visuals and icons on IDEFIX, naming conventions have been defined.

#### IDEFIX naming conventions

Photographers should submit visuals with file names in accordance with the following naming conventions. The file name consists of 6 parts, for example, photo number 001 from IDEFIX is used:



001\_NL-Amsterdam-Museumplein\_Ir (hra)

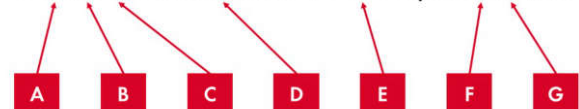

- A:** Assign a sequence number starting with 001. The IDEFIX team will finalise these sequence numbers after approval
- B:** Separate the sequence number from the next part of the name with an underscore '\_'



- | **C:** Country abbreviation according to international standard (use EU for general purpose visuals and those not related to a specific country)
- | **D:** Name of the city where the photo was taken, in English
- | **E:** Name of the parking facility, location or other POI where the photo was taken
- | **F:** Separate descriptive photo name from the suffix with an underscore ' \_ '
- | **G:** Add the resolution code
  - | lr = low res
  - | lr (hra) = low res, high res available
  - | hr = high res

Name elements C, D, E and F are joined by a hyphen.

If more information is required, another suffix can be added to part E. As an example, 'before' and 'after' was added to the location/POI part of the name. Use the same principle for 'day' and 'night' photos taken from the same location. Note also that the numbers of these visuals must be incremental (+1) so that these are located next to each other in the database.

### File types and quality

All visuals are to be provided as .JPG files. This is a uniform file type and is usable on all types of computer systems and programs. When using compression utilities to transform file types to JPG, the quality loss is negligible and still reduces the file size.

When saving files, remember that for print work (see "high resolution visuals") the image option quality should be at least 8 when saving JPG files with e.g. Adobe Photoshop.

### Photo resolution

In the naming conventions section, a distinction is made between low resolution (lr) and high resolution (hr).

#### Low resolution (lr)

Photos with this resolution can be used for PowerPoint presentations, memo's and reports. The minimum quality is specified as follows:

- | Resolution 1024 x 768
- | Quality 72 dpi
- | Colour settings sRGB IEC61966-2.1
  - | sRGB has a small colour range which is a safe standard to work with as most systems recognise this colour range



#### High resolution (hr)

High resolution photos can be used for print work of corporate reports, posters and other marketing collateral. The minimum quality is specified as follows:

- | Quality 300 dpi
- | Colour settings Adobe RGB
- | Adobe RGB has a much higher colour range than sRGB, so there is less risk of quality loss

## File properties

Additional information about the photo should be added to the Properties --> details section:

- | Author = name of photographer
- | Description = e.g. location in parking facility
- | Tags
- | Copyright status:
  - | Is there copyright?
  - | Who owns the rights?
  - | What has been agreed upon with the photographer!

## Rights and consent

### Photography rights

Agreements with photographers must be worded to ensure that Q-Park has unlimited use of any photographs uploaded to Idefix and that Q-Park owns international copyright to these images. If formal arrangements need to be made, make them in line with international standards. The arrangements agreed must be signed and documented.

### Persons consent

All employees and members of the public captured (recognisable) on the visuals must give their consent to be photographed and must sign the appropriate consent form indicating their approval and allowing Q-Park to use these visuals for in- and external international commercial purposes.

Consent form must be completed and signed before the photoshoot is completed.

### Photo disclaimer

It is advisable to include a photo disclaimer on the website (or other public usage of the visual) as most visuals are primarily taken in public places.

If Q-Park does not own the copyright to a photo used on the website or in another publication the photographer who owns the copyright must always be credited.



**Consent form employees**

Please adapt/adopt the copy according to country specific needs and place it in a relevant Q-Park template.

**Concept text**

Subject: Consent to use portrait visuals

Dear colleague,

Q-Park likes to use visuals of employees, taken while working for Q-Park, in its promotional material.

By means of this agreement, we are asking you to explicitly give your consent for this. If you agree to the conditions stated in this letter, we kindly request you to enter your details and sign the letter for approval, and then to return it to the Marketing Department. Remember to keep a copy for yourself.

Q-Park <The Netherlands>, with offices at <address, postal code and city>, further referred to as 'Q-Park', and <first and last name>, further referred to as 'employee' agree the following:

Employee consents to the agreed pose category and/or working environment:

- | Yes/No: Portrait
- | Yes/No: Working environment (office and/or Q-Park Control Room)
- | Yes/No: Parking facility

Employee contact details:

- | Location (office/parking/other):
- | Position within Q-Park
- | Q-Park telephone number
- | Q-Park e-mail address

Parties have agreed as follows:

**Clause 1**

Employee agrees that the visuals may be used for Q-Park's promotional purposes in material such as, but not limited to, internal communications, intranet, Q-Park website, and external communication means

such as posters, flyers, stock images etc. For its own promotional purposes, Q-Park is permitted to share visuals of the employee with third parties.

**Clause 2**

Q-Park is expressly forbidden to use, or have used, visuals, or parts thereof, for creating images that detract from the original subject or design of the assignment, or that may cause damage to the intentions, integrity and/or privacy of the employee or Q-Park.

**Clause 3**

Q-Park will not divulge information to third parties that may infringe the employee's privacy, such as personal details, unless the employee has given prior consent to do so.

We trust we have set out our agreements clearly. Should you have any questions concerning this agreement, please contact the Marketing Department.

Kind regards,  
<Q-Park company name>  
<Name of Marketing Manager>

Signature:

Date:

<Employee name>  
<Employee position>

Signature:

Date:

**Consent form text for the public**

Please adapt/adopt the copy according to country specific needs and place it in a relevant Q-Park template.

**Concept text**

**Thank you for participating in our photo shoot.**

We kindly request you to enter your name and contact details and sign this consent form. By doing this you

---

agree that we may use the photos on our website or in other expressions and marketing materials. Thank you for your cooperation.

Person portrayed (or legal representative if under 18)

Signature:

**Model contract Q-Park <country>**

Date:

**Contact details Q-Park:**

Organisation / contracting party:

Q-Park contact person:

Photographer:

Advertising agency:

Contact person:

Telephone:

E-mail:

**Contact details of person portrayed:**

Name:

Address:

Postcode:

Town:

Telephone:

E-mail:

Bank account number (IBAN):

The person portrayed waives any portrait rights as stated in <country copyright law>. Q-Park <country company name> pays a one-off fee of € xxx for these rights.

The person portrayed expressly consents to Q-Park's unlimited use of his/her photographs in public places including but not limited to: Q-Park websites, communications via social media and other means.

**Signatures**

Q-Park representative

Signature:

Date:

# APPENDICES

---

## Brand Identity don'ts

### Logo don'ts

Only use the logo as downloaded, never attempt to change it in any way.

The following logo examples may look okay to the untrained eye, but these are wrong because:

- I In the black example, the 'angled parking spaces' are disconnected.
- I The logo may not be monochrome grey, and the Q is too small.
- I In the red example, the 'angled parking spaces' must be black.

The black logo on a red background is only permitted for company clothing and litter bins in parking facilities.

- I In the left-hand example, the pay-off is not aligned properly.
- I In the right-hand example, the pay-off is translated.

Translating the pay-off 'Quality in parking' is not allowed.

These logo's with pay-off are wrong because:

Figure 83: Logo don'ts

---



Figure 84: Logo and pay-off don'ts

---



- The following logo-name variants are wrong because:
- | We do not change or bastardise the company name or logo in any way.
  - | We do not add country names to the logo.
  - | We do not add company names to the logo.

Figure 85: Logo and naming don'ts

No deviations of any kind from or changes to the logo or its use in combinations are permitted.

The logo is never displayed with or incorporated into any other image or text in altered form.

In the event of acquisitions, mergers and other forms of participation, the Q-Park brand will be introduced throughout all aspects of the business concerned.

### Visual don'ts

- | Don't overlap images.
- | Don't use image collages.
- | Don't skew images.
- | Don't use duotones.
- | Don't use irrelevant images to fill in space.
- | Don't place images and logos randomly in every empty (white) space. White space is one of the Q-Park Brand Identity elements!
- | Don't frame an image (nor use borders).

## Brand Points

### 2020 / 2021

#### Q-Park Brand Points – February

- | **Q-Park Wallpapers:** just a gimmick, wallpapers are available for your mobile phone

#### Q-Park Jargon

- | | P+R (not P&R) – we use the plus-sign ... + ... for P+R (Park+Ride) to align with public parking signs.
- | (We use the and-sign ... & ... mostly for internal combinations (Pay & Display for example)).

#### Q-Park Recap

- | | The Brand Points Series was initiated to put a bit of fun/focus on the Q-Park Brand
- | | You may always contact Sacha Oerlemans regarding any Q-Park Brand query
- | | On Idefix, you can find a great amount of practical tools amongst which: Q-Park Slide Deck, Q-Park Visuals, Q-Park Icons, Q-Park Templates, etc etc.

#### Q-Park Brand Points – December

#### Q-Park Season's Greetings

- | | Will be shared by e-mail and SocialSeeder campaign

- | Please share with business relationships, family and friends as you see fit – every unique click means we donate EUR 10 to Cordaid

### | **Q-Park PowerPoint 2021** (template updated with 2021 in the footer)

- | The rest is identical to the April 2020 template
  - | No Q-Park logo in the top-right corner – i.e. more space for headers
  - | No grey bar at the bottom (upon request)
- | If you wish to change the Title slide visual, click on the visual, delete and replace it, then select the Layout Title slide\*
  - | Approved visuals of can be found on Idefix/Pictures and Idefix/We Develop Quality
  - | Approved visuals may be created from Shutterstock (we have an account)
- | When adding a new slide, select one of the pre-defined layouts which fits your needs
  - | \*Select Home / Layout ... or ... Right-mouse-click and select Layout
  - | The layout 'Image bleed' allows for a more 'dramatic / visual story' effect

### **Q-Park Jargon**

- | Programme (not Program)
  - | Q-Park Programmes such as the LED Programme, CyberSecurity Programme etc are written in British English
  - | Program is American English or used for software only (i.e. software program)
- | Parking facility - we prefer to talk about parking facilities (not car parks) as we allow for more than cars to park at Q-Park i.e. bicycles, coaches etc

### **Q-Park Brand Points – November**

#### **Q-Park Colours**

- | Some of us just need more colour than the standard Q-Park Red, Black & White
- | A Q-Park Charts & Graphs Colour Exercise, can be found on Idefix

#### **Q-Park Expertise** (available online and in pdf)

- | Showcases & Articles - Q-Park has a vast amount of information available;
  - | Showcases highlight specific features which make Q-Park ... Q-Park
  - | Articles highlight our expertise on a variety of parking related topics
- | Information Platform
  - | You and any other interested party are invited to register for our Information Platform
  - | I solicit your input on topics for which a showcase or article should be created

#### **Q-Park Jargon**

- | Motorists (not drivers) – we use the word motorists for our parking customers (and the word drivers to address business drivers such as capital, employees, technological advancement)
- | Parking spaces (not places, spots, ...) – we provide space, that's what we do (spots may be perceived as a stain, i.e. a floor has spots)

- | **Q-Park Collateral:** Q-Park branded face-masks are available

### **Q-Park Brand Points – October**

Did you know that:

- | **Q-Park Brand** is a masculine brand – based on its colours and shapes
  - | Q-Park logo has 3 distinct angled parking spaces in its logo – 2 at the end, 1 in the Q
  - | Q-Park is written with a capital Q and P with a hyphen in between (not q-Park, Q-park, Q Park, etc)



I Use white text on red (not black, that doesn't work for the colourblind)

I **Q-Park Presentation** contents and tools are available:

I Q-Park Slide Deck can be found on Idefix, this is a 'deck', not a presentation

I Please select and adapt as you see fit- Information and/or references can be found in the speaker notes

I This is never finished, if you have needs, please contact undersigned

I Q-Park has a Shutterstock and a PresenterMedia account <sup>2</sup>

I **Q-Park Jargon** – Season tickets (not subscriptions)

I This is a tough one as in most languages 'abonnement' works fine – not in Queens English

I A subscription is something that comes to you (a magazine, newspaper, etc)

I A season ticket is something you go to (football, theatre, parking)

I **Q-Park Templates** (Excel, Word & PowerPoint) are available:

I On Idefix

I Or get them automatically by inserting a link in your personal templates location

I In PowerPoint, go to File / Options / Save / Default personal templates location:

I Insert the link: \\qpark325.q-park.com\IDEFIX\Templates\Office

I In PowerPoint, select New ... go to the tab **Personal** ... and you'll find the Q-Park template

I Once you've selected this template it will be pinned for future selection

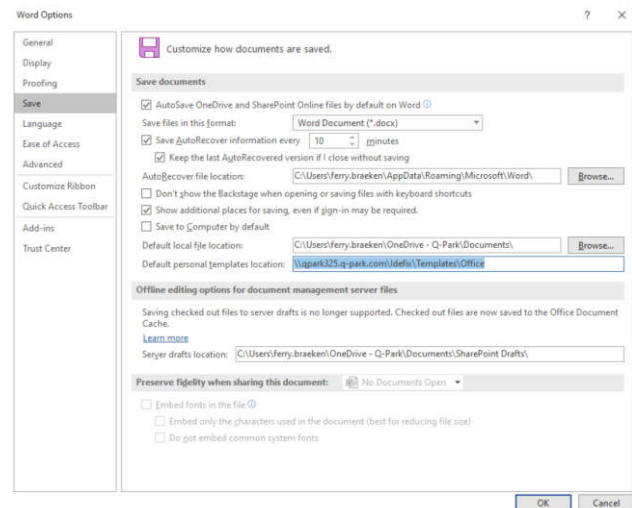

## Q-Park Brand Points – September

Did you know that:

I The Q-Park trade name was valued at EUR 65.9 million in 2019 (yes, our brand is an asset).

I Approved Q-Park items can be found on the Idefix drive (T drive), including icons and pictures.

I There is a Q-Park Brand Identity Manual. Please share with partners when needed.

I If you like to have a Q-Park A5 Notepad and/or a Q-Parker Pen – just ask.

## Q-Park Brand Points – Rational

You may know the expression: There's an R in the month (indicating that the weather is getting colder and the days shorter). So I thought, why not put a bit of fun/focus

on the Q-Park Brand when there is a B in the month. Sure enough, the Q-Park Brand is always important but sometimes it gets on the back burner. In other words, you may expect Q-Park Brand Points in September, October, November, December and February.

**Q-Park Brand Points – Support**

Regardless which time or day, you may contact me regarding any Q-Park Brand Point you may have. I'm happy to assist and/or optimise in any way possible.



**Q-Park has assured a number of its activities under NEN-EN-ISO 9001.**

**Q-Park has received several ESPA and EPA awards.**

For more details and up-to-date information about Q-Park's products and services please visit: [www.q-park.com](http://www.q-park.com).

©2025 Q-Park BV, Published under own management. All rights reserved.

---



Q-Park BV  
PO Box 1166  
6201 BD Maastricht  
**T** +31 433 297 171  
**F** +31 433 297 172  
**I** [www.q-park.com](http://www.q-park.com)

---